

Procedures and Guidance Notes for working with biological agents and materials*

No.	Procedure / Guidance note title	Page
B01	Biological Agents List	02
B02	Selecting an ACDP Hazard Group for biological materials	04
B03	Selecting a Containment Level for cell cultures	06
B04	ACDP Containment Level 1 Requirements	07
B05	ACDP Containment Level 2 Requirements	09
B06	ACDP Containment Level 3 Requirements	12
B07	Specified Animal Pathogen Containment Requirements	17
B08	Prevention of Blood-borne Infections	25
B09	Microbiological Safety Cabinets	33
B10	Safe Working Practices in Biological Laboratories	46
B11	Centrifugation of Biological Material	51
B12	Sterilisation and Disinfection	54
B13	Fumigation	62
B14	Autoclave operation	69
B15	Transport and receipt of Biological Agents	75
B16	Bio security	94
B17	Working with agents causing TSE's	95

*This document must be read in conjunction with the QMUL Policy for Working with Biological Hazards

http://www.hsd.qmul.ac.uk/media/hsd/documents/standards-and-guidance/QMUL_HS_118_June-2017_Policy-for-Working-with-Biological-Hazards-V3.pdf

And relevant A-Z information webpages at <http://www.hsd.qmul.ac.uk/a-z/>

PLEASE NOTE THAT WEBLINKS ARE SUBJECT TO CONTINUOUS CHANGE and published documents or websites / pages should then be searched for using the title or appropriate key words..

Procedure / Guidance Note B01

APPROVED LIST OF BIOLOGICAL AGENTS

The **Approved List of Biological Agents** provides the approved classification of biological agents as referred to in COSHH. It is relevant to risk assessment for work with biological agents and the application of appropriate control measures. It is for use by those who deliberately (intentionally) work with biological agents, especially those in research, development, teaching or diagnostic laboratories and industrial processes, or those who work with humans or animals who are (or are suspected to be) infected with such an agent in health and animal care facilities.

The Advisory Committee on Dangerous Pathogens (ACDP) Approved List of Biological Agents is available at <http://www.hse.gov.uk/pubns/misc208.pdf>),

In addition, specified animal pathogens listed in the Specified Animal Pathogens Order (SAPO) 1998 (as amended) issued by the Department for Environment Food & Rural Affairs (DEFRA) and Schedule 5 of the Anti-Terrorism, Crime and Security Act 2001 (as amended) issued by the Home Office also have specific measures which must be taken into account for risk assessment of work.

Please visit the following web links for the full lists issued by DEFRA and the Home Office.

<http://www.hse.gov.uk/biosafety/sapo.htm> (HSE)
https://assets.publishing.service.gov.uk/government/uploads/system/uploads/attachment_data/file/400360/animal-pathogens-guidance-controls.pdf (DEFRA)
<https://www.legislation.gov.uk/ukpga/2001/24/schedule/5> (Home Office)

The receipt, handling, use or disposal of ACDP Hazard Group 4 agents, SAPO Group 4 and higher risk pathogens in Schedule 5 (or material likely to contain them) is **not** permitted under any circumstance at Queen Mary University of London.

Any biological agent not listed in the above list/s should initially be checked against the official lists, and also take into account possible changes in nomenclature. The names of biological agents, especially bacteria, are subject to change, and any unlisted agent should **not** automatically be assumed to be in hazard group 1 / SAPO Group 1.

Unlisted agents should be assessed for hazard by reference to any known or suspected pathogenic properties. If in doubt, please contact the QMUL Biological Safety Adviser (<http://www.hsd.qmul.ac.uk/contact-us/>).

All new pathogens (from autumn 2016) to be used **deliberately or intentionally** at QMUL **must** follow the peer review process conducted by the QMUL BGMSC
<http://www.hsd.qmul.ac.uk/a-z/health-and-safety-advisory-group/health-and-safety-adviosry-group/bgmisc/>

The following key is used in the Approved List of Biological Agents and must be taken into account for the risk assessment:

A: Known allergenic effects.

B: A list of workers exposed to this agent should be kept for 40 years following the last known exposure.

V: an effective vaccine is available.

T: Toxin production.

S: listed under Schedule 5 of the Anti-Terrorism, Crime and Security Act 2001 (as amended).

D: listed under the Specified Animal Pathogens Order (SAPO) 1998 (as amended).

Procedure / Guidance Note B02

Selecting an ACDP Hazard Group for biological materials

The following is given as a guide only – an assessment must be conducted to evaluate the risks from the material taking into account the amount and titres used, modifications made (eg genetic manipulation), procedures undertaken, the persons who handle or may be exposed to it and the impact on the environment.

MATERIAL	APPROPRIATE HAZARD GROUP (HG)
Human blood	Normally HG 2 but HG 3 if HG 3 infectious agents suspected.
Human brain	Normally HG 2. HG 3 if Creutzfeld-Jacob infection suspected, but derogation from full Containment Level 3 may be sought ⁶ .
Human sputum and lung tissue	Consider as HG 3 if <i>Mycobacterium tuberculosis</i> (Mtb) is suspected. HG 2 if Mtb unlikely on clinical grounds but microbiological safety cabinet must be used (unless Mtb eliminated by microbiological tests).
Cell cultures	See Procedure / Guidance Note B03.
Other human material	Normally HG 2. Consider as HG 3 if HG 3 agents are suspected.
Non-human primate material	Normally as for human tissues (see above). Consider as HG 3 if sero-positive for Hepatitis B virus or of unknown status.
Viral nucleic acid	As for intact virus.
Sewage, sludge, polluted water etc.	Normally HG 2.
Other environmental samples	Normally HG 1 or 2 depending on risk, consider as HG 2 for unidentified organisms cultured from samples.

Microbial toxins

At least as for source organism - depends on concentration factor.

Note:

Culture of own or close colleagues' blood cells, other cells or tissues

Staff and students must not culture their own or should not culture close colleagues' blood cells.

It is inadvisable to culture one's own or close colleagues' cells or tissues and unacceptable to use such cells in genetic modification experiments or if there is any risk of the cells becoming transformed in culture. The concern stems from the potential failure of the immune system to recognize as foreign a cell that has been deliberately or inadvertently transformed or modified *in vitro* if these cells are re-introduced into the original donor.

Additional notes:

1. Transformation of one's own cells is dangerous and must not be done.
2. When cells are cultured (in particular when they are deliberately immortalized) then the risk to the donor of these cells subsequently being recognised as "self" in the event of an inoculation accident should be recognised. Donors are not permitted to handle their own immortalised cells or cells in long term culture where there is the risk of spontaneous transformation.
3. A donor must not be present in the laboratory at any time when their cells are being handled by others and preferably should not have any access to these laboratories.
4. A similar restriction applies to the use of host cells capable of colonising workers, for example the workers own cells or those from other workers having access to the laboratory, in genetic modification activities involving the use of viral vectors.
5. Records of primary cell cultures and the individuals from whom they were isolated should be kept.

Selecting Containment Level for Cell Cultures

The following is given as a guide only – a risk assessment must be conducted to evaluate the hazardous nature of the material taking into account the amounts handled, modifications made (eg genetic manipulation), procedures undertaken, the persons who handle or may be exposed to it and the impact on the environment. Any work that could give rise to infectious aerosols must be carried out in suitable containment (eg a microbiological safety cabinet)*.

Hazard	Cell type	Baseline Containment Level (CL)
Low – uncertain	well characterised/authenticated finite cell lines of human or primate origin non-human, non-primate cell lines which have been authenticated, have a low risk of endogenous infection with a human pathogen and present no apparent hazard to laboratory workers	CL1*
Medium – uncertain	cell lines/strains not fully authenticated or characterised	CL2 and use of a microbiological safety cabinet
High – defined	cells with endogenous pathogens and cells deliberately infected	containment appropriate to the pathogen (ie if infected with Hepatitis B virus then CL3 required)
High – uncertain	primary cells from blood, lymphoid cells, neural tissue of human or simian origin	containment appropriate to the potential risk. A minimum of CL2 recommended.

Requirements for Containment Level 1

1. The laboratory should be easy to clean. Bench surfaces must be impervious to water and resistant to acids, alkalis, solvents and disinfectants.
2. Effective disinfectants must be available for immediate use in the event of spillage.
3. If the laboratory is mechanically ventilated, it is preferable to maintain an inward airflow while work is in progress by extracting room air to atmosphere.
4. All procedures must be performed so as to minimise the production of aerosols.
5. The laboratory door must be closed when work is in progress.
6. Laboratory coats or gowns must be worn in the laboratory at all times and removed when leaving the laboratory suite.
7. Personal protective equipment, including protective clothing, must be:
 - stored in a well-defined place;
 - checked and cleaned at suitable intervals;
 - when discovered to be defective, repaired or replaced before further use.
8. Personal protective equipment, which may be contaminated by biological agents, must be:
 - removed on leaving the working area;
 - kept apart from uncontaminated clothing;
 - decontaminated and cleaned or, if necessary, destroyed.
9. Eating, drinking, taking medication, smoking, storing food and applying cosmetics must be forbidden.
10. Mouth pipetting is forbidden.
11. The laboratory must contain a basin or sink that can be used for hand washing.
12. Hands must be decontaminated immediately when contamination is suspected and before leaving the laboratory.
13. Bench tops must be cleaned after use.
14. Used glassware and other materials awaiting disinfection must be stored in a safe manner. Pipettes, for example, if placed in disinfectant, must be totally immersed.
15. Contaminated materials whether for recycling or disposal, must be stored and transported in robust and leak-proof containers without spillage.

16. All waste material, if not to be incinerated, must be disposed of safely by other appropriate means.
17. Accidents and incidents must be immediately reported to and recorded by the person responsible for the work or other delegated person.

Requirements for Containment Level 2

1. Access to the laboratory is to be restricted to authorised persons.
2. There must be specified disinfecting procedures.
3. If the laboratory is mechanically ventilated, it must be maintained at an air pressure negative to atmosphere while work is in progress (see 17 below.).
4. Bench surfaces must be impervious to water, easy to clean and resistant to acids, alkalis, solvents and disinfectants.
5. There must be safe storage of biological agents.
6. Laboratory procedures that give rise to infectious aerosols must be conducted in a microbiological safety cabinet, isolator or be otherwise suitably contained.
7. There must be access to an incinerator for the disposal of infected animal carcasses (see 24 below).
8. Personal protective equipment which may be contaminated by biological agents must be:
 - stored in a well-defined place;
 - checked and cleaned at suitable intervals;
 - when discovered to be defective, repaired or replaced before further use.
9. Personal protective equipment which may be contaminated by biological agents must be:
 - removed on leaving the working area;
 - kept apart from uncontaminated clothing;
 - decontaminated and cleaned or, if necessary, destroyed.
10. There should be adequate space (24m³) in the laboratory for each worker.
11. The laboratory door must be closed when work is in progress.
12. Laboratory coats or gowns, which must be side or back fastening, must be worn and removed when leaving the laboratory suite. Separate storage (for example, pegs) apart from that provided for personal clothing must be provided in the laboratory suite.
13. Eating, chewing, drinking, smoking, taking medication, storing food and application of cosmetics in the laboratory must be forbidden.
14. Mouth pipetting is forbidden.
15. When undertaking procedures that are likely to give rise to infectious aerosols, a Class I microbiological safety cabinet (installed to BS 5726:2005 parts 2 & 4 and

with performance adhering to European Standard BS EN 12469:2000) or a unit with equivalent protection factor or performance (eg Class II MSC) must be used.

16. Safety cabinets should exhaust to the outside air or to the laboratory air extract system. Although a single HEPA filter for Class II MSC exhaust air is deemed adequate by the standard, within QMUL it is recommended that all re-circulating Class II cabinets be installed with double HEPA filters on the exhaust to ensure they are suitable for work with other micro-organisms (see Procedure / Guidance B09 below).

17. In most laboratories operating at Containment Level 2 where there is mechanical ventilation simply to provide a comfortable working environment, it may not be practical to maintain an effective inward flow of air. The often-constant traffic in and out of Containment Level 2 rooms may interfere significantly with attempts to establish satisfactory airflow patterns.

Where a laboratory is ventilated specifically to contain airborne pathogens in the event of an accident, then engineering controls and working arrangements must be devised so as to counter the risk of airborne transmission to other areas. Maintaining an inward flow of air is necessary only when work is in progress. 'Atmosphere' in this context may be taken to mean either the external air and/or other parts of the laboratory suite or building.

18. The laboratory must contain a wash hand basin located near the laboratory exit. Taps must be of a type that can be operated without being touched by hand.

19. Hands must be decontaminated immediately when contamination is suspected, after handling infective materials and before leaving the laboratory. When gloves are worn, these must be washed or preferably changed before handling items likely to be touched by others not wearing gloves, for example telephones, paperwork. Computer keyboards and, where practicable, equipment controls should be protected by a removable flexible cover that can be disinfected.

20. An autoclave for the sterilisation of waste materials must be readily accessible in the same building as the laboratory, preferably in the laboratory suite.

21. Bench surfaces must be regularly decontaminated according to the pattern of the work.

22. There must be a means for the safe collection, storage and disposal of contaminated waste.

23. Contaminated waste must be suitably labelled before removal for incineration. Such waste must be transported in robust and leak proof closed containers.

24. 'Access to an incinerator' – see paragraph 7 above, may be taken to mean an incinerator at another site but whether local or distant, carcasses for incineration must be transported in closed leak proof, robust and secure containers.

25. Used laboratory glassware and other materials awaiting sterilisation before recycling must be stored in a safe manner. Pipettes, if placed in disinfectant, must be totally immersed.

26. All accidents and incidents must be immediately reported to and recorded by the person responsible for the work or other delegated person.

References

The Management, Design and Operation of Microbiological Containment Laboratories, HSE Books 2001. ISBN 0 7176 2034 4

Control of Substances Hazardous to Health (Fifth edition): The Control of Substances Hazardous to Health Regulations 2002 (as amended), Approved Code of Practice and Guidance, HSE Books, HMSO, ISBN 0 7176 2981 3.

Standards referred to:

BS EN 12469:2000. Biotechnology. Performance criteria for microbiological safety cabinets, ISBN 0 580 34869 5.

BS 5726 Microbiological safety cabinets – Information to be supplied by the purchaser to the vendor and to the installer, and siting and use of cabinets – Recommendations and guidance 2005. ISBN 0 580 45590 4.

Requirements for Containment Level 3 Facilities¹

A General requirements

1. The laboratory must be separated from other activities in the same building.
2. A laboratory is a room with four walls and a ceiling.
3. Access to the laboratory is to be restricted to authorised persons.
4. The laboratory must be maintained at an air pressure negative to the atmosphere. Extracted air must be HEPA filtered (or equivalent).
5. The laboratory must be sealable to permit disinfection.
6. There must be specified disinfection procedures.
7. Bench surfaces and the floor must be impervious to water, easy to clean and resistant to acids, alkalis, solvents and disinfectants.
8. There must be safe storage for biological agents.
9. There must be an observation window or an alternative so that the occupants can be seen.
10. The laboratory must contain its own equipment, so far as is reasonably practicable.
11. Laboratory procedures that may give rise to infectious aerosols must be conducted in a microbiological safety cabinet, isolator or using other suitable containment.
12. An incinerator must be accessible for the disposal of animal carcasses.
13. Personal protective equipment, including protective clothing, must be:
 - stored in a well-defined place;
 - checked and cleaned at suitable intervals;
 - when discovered to be defective, repaired or replaced before further use.
14. Personal protective equipment which may be contaminated by biological agents must be:
 - removed on leaving the working area;
 - kept apart from uncontaminated clothing and equipment;
 - decontaminated and cleaned, or, if necessary, destroyed.

15. There should be adequate space (at least 24 m³) in the laboratory for each worker.
16. The laboratory door must be closed when work is in progress and locked when the room is unoccupied. A biohazard sign must be posted at the entry to the laboratory.
17. Side or back fastening laboratory gowns or coats must be worn in the laboratory and removed on leaving it. These must be autoclaved before being sent for laundering. Additional protection, for example, gloves and plastic aprons, must be also be made available.
18. Eating, drinking, mouth pipetting, smoking, taking medication, storing food and applying cosmetics are forbidden in the laboratory.
19. A Class I or Class III microbiological safety cabinet (performing to BS EN 12469:2000 and installed to BS 5726:2005 parts 2 & 4 or unit with equivalent protection factor or performance) are the most suitable for laboratory procedures likely to give rise to infectious aerosols. In some cases, equipment that is designed to contain aerosols at source may be in use (eg isolators) but its integrity in this respect must be verified before it is accepted as an alternative to containment of the work in a safety cabinet. Where protection of the work is essential (for example cell cultures are in use) and the route of transmission of the agent concerned is primarily percutaneous, a Class II safety cabinet may be used provided that it can be shown to offer operator protection to the standard of BS EN 12469:2000 under the conditions of use.
20. Laboratory or animal isolators currently have no defined British or European Standard although general guidance is given². From a containment perspective, there are many similarities between a Class III microbiological safety cabinet and an isolator and therefore isolators should aim to provide a similar level of protection as afforded by a Class III cabinet².
21. Safety cabinets must exhaust through a HEPA (High Efficiency Particulate Absorption) filter or equivalent to the outside air or into the laboratory air extract system. In all other respects such as siting, performance in use, protection factor and air filtration, the cabinet must comply with the performance specifications detailed in BS EN 12469:2000 and BS 5726:2005 parts 2 & 4.
22. Only filters tested in accordance with and matching the requirements of BS EN 1822:2000 must be used. If laboratories are faced with a major problem because of difficulties in arranging for the cabinet to exhaust to open air, recirculation of exhaust air through two HEPA filters in series may, *in exceptional circumstances*, be considered as an alternative. In this case, the maintenance of a continuous airflow into the laboratory during work with infectious material will be of particular importance and such an option *must not be adopted without prior consultation with the HSE*.

23. A wash basin must be provided near the exit of the laboratory. Taps must be of a type that can be operated without being touched by hand.
24. Gloves must be worn for all work with infective materials and hands must be washed before leaving the laboratory. Gloves must be washed or preferably removed before touching items that will be touched by others not similarly protected, for example telephone handsets, paperwork. Computer keyboards and, where practicable, equipment controls must be protected by a removable flexible cover that can be disinfected.
25. An autoclave for the sterilisation of items to be recycled and/or waste materials must preferably be situated within the laboratory, but if this not practicable, then one must be readily accessible in the laboratory suite.
26. Materials for autoclaving must be transported to the autoclave in robust containers without spillage.
27. There must be a means for the safe collection, storage and disposal of contaminated waste.
28. Contaminated waste must be suitably labelled before removal for incineration.
29. 'Access to an incinerator' may be taken to mean an incinerator at another site but whether local or distant, carcasses for incineration must be transported in secure containers.
30. COSHH requires that the Containment Level 3 laboratory be sealable to permit disinfection³. While the definition of 'disinfection' may be widely interpreted, in practice, it may be necessary, subject to the assessment of risk, to decontaminate by fumigating the accommodation when, for example, a spillage has occurred or when maintenance work is to be carried out.
31. Where it is not reasonably practicable for the laboratory to contain its own equipment, for example, a deep-freezer, material must be transported and stored without spillage in properly labelled robust containers which must be opened only in Containment Level 3 accommodation.
32. All accidents and incidents must be immediately reported to and recorded by the persons responsible for the work or other delegated persons.

B Achieving an inward flow of air

1. COSHH requires that a Containment Level 3 laboratory is maintained at an air pressure negative to atmosphere³. 'Atmosphere' in this context may be taken to mean the external air and/or other parts of the laboratory suite or building. In effect, this means arranging engineering controls such that a continuous inward airflow into the laboratory is maintained but this is necessary generally only when work with biological agents is actually in progress. Provision should be made for comfort factors, i.e. supply of fresh air, temperature control.

2. One of the following means must be adopted to achieve the inward flow of air:

extracting the laboratory air through independent ducting to the outside air through a HEPA filter (or equivalent);

extracting the laboratory air to the outside air with a fan and HEPA filter (or equivalent) sited in a wall or window of the laboratory;

ducting the exhaust air from the microbiological safety cabinet to the outside air through a HEPA filter (or equivalent);

or a safe variation of these methods.

Whichever method is used, the requirement of COSHH Regulation 9 referring to maintenance, examination and test of control measures and specifically to 'local exhaust ventilation' must be observed^{3,4}. This means that HEPA filters and their fittings and seals must be thoroughly examined and tested at intervals **not exceeding 14 months**. In practice, depending on the frequency of use, these tests should be carried out at shorter intervals, for example, six monthly.

3. In laboratories with a mechanical air supply system, the supply and extract airflows must be interlocked to prevent positive pressurisation of the room in the event of a failure of the extract fan. The ventilation system must also incorporate a means of preventing reverse airflows. The design of systems to achieve the required inward flow of air must aim for simplicity to avoid the chances of failure due to over-complicated control mechanisms. Instrumentation should be relevant and sensitive to the factors that contribute to safety. Engineers should be asked to consider as a priority the safety features of the room when arranging heating and ventilation and the dispersal of heat generated by equipment. In particular, the influx of cold air and the siting of ventilation outlets and extracts can have a significant effect on the performance of safety cabinets.

References

- 1 The Management, Design and Operation of Microbiological Containment Laboratories, ACDP, HSE Books 2001. ISBN 0 7176 2034 4 <http://www.hse.gov.uk/pubns/priced/microbiologyiac.pdf>
- 2 Guidance on the use, testing and maintenance of laboratory and animal isolators for the containment of biological agents. HSE, 2006. <http://www.hse.gov.uk/biosafety/isolators.pdf>
- 3 Control of Substances Hazardous to Health (Fifth edition): The Control of Substances Hazardous to Health Regulations 2002 (as amended), Approved Code of Practice and Guidance, HSE Books, HMSO, ISBN 0 7176 2981 3. <http://www.hse.gov.uk/pubns/priced/l5.pdf>
- 4 Maintenance, examination and testing of local exhaust ventilation, HSG 258, 3rd edition 1998, HSE Books, HMSO, ISBN 978 0 7176 6613 3. <http://www.hse.gov.uk/pUbns/priced/hsg258.pdf>

Standards referred to:

BS EN 12469:2000. Biotechnology. Performance criteria for microbiological safety cabinets, ISBN 0 580 34869 5.

BS 5726 Parts 2 and 4 Microbiological safety cabinets – Information to be supplied by the purchaser to the vendor and to the installer, and siting and use of cabinets – Recommendations and guidance 2005. ISBN 0 580 45590 4.

BS EN 1822-1- 3:1998 and 4 & 5: 2000: High efficiency air filters (HEPA and ULPA). ISBN 0 580 29837 X, 0 580 29838 8, 0 580 29839 6, 0 580 36458 5, 0 580 36457 7.

Guidance for Biotechnology Operations BS EN 12741:1999

Specified Animal Pathogen Containment Requirements

The Specified Animal Pathogens Order (SAPO) 1998, enforced by the Department of Environment Food & Rural Affairs (DEFRA) in England, prohibits any person from having in his possession any specified animal pathogen listed in Part I of the Schedule to the Order or any carrier in which he knows such a pathogen is present. It also prohibits the introduction into any animal or bird of any pathogen listed in the Schedule to the Order (Parts I and II).

The purpose of the Order is to prevent the introduction and spread into Great Britain of specified animal pathogens which, if introduced, could cause serious disease and economic loss to the British livestock and poultry industries.

The complete list of specified animal pathogens can be found here https://assets.publishing.service.gov.uk/government/uploads/system/uploads/attachment_data/file/400360/animal-pathogens-guidance-controls.pdf and a selected list of pathogens which also affect human health are listed in Procedure / Guidance Note 1.

The Order has no application to any animal pathogen or carrier contained in *licensed* veterinary or human medicines.

Licenses under SAPO 1998 stipulate the way in which the specified animal pathogens covered by the license must be handled to ensure their safe containment and disposal, the areas of the laboratory in which various types of work may be done and the persons responsible for supervising the work. Licenses are usually valid for 5 years.

Containment Requirements for Laboratories to be Licensed to Handle DEFRA Category 2 Pathogens under the Specified Animal Pathogens Order 1998

These requirements were amended in light of recommendation 47 [page 16] of the Health and Safety Executive's '[Final report on potential breaches of biosecurity at the Pirbright site 2007](#)'.

SAPO Guidance issued can be found at <http://www.hse.gov.uk/pubns/priced/hsg280.pdf>

The following describes the physical features and operating conditions which would be likely to be required by DEFRA of any laboratory to be licensed to hold or work with DEFRA Category 2 pathogens. It is concerned with preventing the escape of pathogens from the laboratory and not primarily with ensuring the safety of the workers. It does not in any way limit the obligations placed upon employers and employees by the Health and Safety at Work etc Act 1974 in general and COSHH in particular, or the Health and Safety Executive's duty to enforce these obligations. Extra precautions will often be necessary for the safety of the staff.

The laboratory - siting and structure

1. Whereas the laboratory need not be physically separated from other laboratories it should not be sited next to a known fire hazard (e.g. the solvent store) or be in danger of flooding.
2. Access to the laboratory should be limited to laboratory personnel and other specified persons.
3. The entrance to the laboratory should have a clearly defined clean and dirty side over which staff don or remove protective clothing and wash their hands.
4. The laboratory must be proofed against entry or exit of animals or insects. This is particularly important in the case of diseases which can be spread by insect vectors.
5. Liquid effluent containing specified pathogens should be treated by a procedure known to kill the relevant pathogens. Since this procedure may take some time, it may be necessary to have more than one standing tank if work is to be carried out continuously. The standing tank(s) and recording equipment form parts of the facilities of the laboratory, so the Safety Officer is responsible for ensuring their proper functioning.

Laboratory facilities

1. The laboratory must be equipped with a Class I, II or III exhaust protective cabinet where procedures likely to generate aerosols will be used e.g. homogenisation.
2. All waste biological material containing specified pathogens must be sterilised prior to removal from the laboratory site. Therefore, each laboratory should have access to an autoclave. There should be no possibility of removing the load without the autoclave cycle having been completed. As soon as practicable after the completion of the autoclave cycle, the load should be taken to an incinerator and immediately incinerated. Autoclaves should be monitored to ensure that time / temperature cycles are completed and records should be kept.
3. Each member of staff working in the laboratory must have adequate working space.
4. Specified pathogens should be stored in the laboratory and in suitable containers (depending on the mode of storage, frozen or freeze-dried) in a cabinet reserved for specified pathogens and kept under lock and key. A key should be available on demand only to nominated individual(s). Where storage in the laboratory is not reasonably practicable, material must be transported and stored without spillage in properly labelled robust containers which must only be opened in the Category 2 laboratory. Physical security measures similar to those in place at the laboratory must be in place at the site of storage.

Protective clothing

1. Laboratory gowns must wrap over the chest and fit tightly at the wrists. Ordinary white laboratory coats are UNSUITABLE. Staff should have a clean gown for each uninterrupted period spent in the laboratory. Other types of clothing giving the same degree of protection may be acceptable.
2. Gowns must not be used outside the laboratory suite. They should be autoclaved before they are removed from the laboratory.
3. Gloves must be worn for all work with infective materials and workers must wash hands before leaving the laboratory.

Safety Officer

NOTE: Throughout this document the term Safety Officer refers to a person having responsibility for work with specified pathogens.

1. A Safety Officer able to advise on infectious hazards, and a deputy, must be appointed or designated. The establishment may have a Safety Officer with general responsibility for such hazards. If not, an additional individual must be designated.
2. A Safety Officer should have appropriate qualifications and laboratory experience in working with specified pathogens.
3. The Safety Officer will act as adviser to the Head of the Department in all matters which may affect the containment of the pathogens and should be authorised to stop practices considered unsafe, pending guidance when necessary, from the laboratory Head.
4. He or she will take control, implement first aid in, and investigate all accidents in laboratories and take what other action he considers necessary.
5. Where their responsibilities are not sufficient to warrant their full-time employment as Safety Officer, provided that they are readily accessible to the laboratory during normal hours, they may hold another appointment.
6. He or she will be responsible for the safe storage of specified pathogens and the maintenance of the inventory.
7. He or she will be responsible for organising the admission to the laboratory of cleaners and maintenance personnel and for the disinfection of any apparatus, etc. which is to be removed.
8. He or she will be responsible for advising staff on all aspects of the application of these Safety Precautions.

Training in handling specified pathogens

1. The Safety Officer will organise the initial training of staff in the safe handling of specified pathogens.
2. Training will cover, e.g. the correct use of safety hoods, exhaust protective cabinets, pipettes, syringes / needles, hot / cold rooms, centrifuges, blenders, freeze-driers, shaking machines, ultrasonic disintegrators, glassware and the disposal of contaminated protective clothing and laboratory materials.
3. Staff should only work with specified pathogens if they have some previous experience in microbiology and have had a course of training supervised by the Safety Officer.

Supervision

1. Work in the laboratory must, at all times, be carried out by, or be supervised by, a senior, trained and experienced member of the staff.
2. The supervisor will be personally responsible to the Safety Officer for the safety of the work actually in progress at any time, although he or she may not be responsible for the overall project.

Laboratory discipline

1. The containment area of each laboratory must be identified clearly with appropriate warning notices.
2. When unoccupied, the laboratory must be locked. The key(s) must be kept under the supervision of the Safety Officer, and released only to authorised persons. A key, however, should be kept at a secure control point, available at all times, in case of emergency.
3. In normal hours the supervisor will be responsible to the Safety Officer for ensuring that no unauthorised person enters the laboratory.
4. Only the Safety Officer or his deputy may authorise staff to enter the laboratory, and he or she will hold a list of names of personnel so authorised.
5. Unlisted persons (e.g. visitors, observers, cleaners or maintenance / repair personnel must not enter the laboratory unless they have received a signed statement from the Safety Officer that it is safe for them to do so.
6. The Safety Officer will be responsible for confirming when a laboratory and its apparatus have been disinfected.
7. The laboratory door must be closed whilst work is in progress. No food, drink, tobacco, make-up, etc. may be taken inside. Clean protective clothing should be put on. The 'clean' and 'dirty' areas should be clearly distinguished physically.
8. On the way out, over garments should be removed and before leaving the laboratory the individual must wash hands.
9. This procedure should be adhered to whenever, and for whatever purposes, the room is vacated.
10. All accidents or spillage of potentially dangerous material in the laboratory must be reported IMMEDIATELY to the Safety Office. EVERY SUCH INCIDENT MUST BE REGARDED AS A FULL MEDICAL OR ANIMAL DISEASE HAZARD.
11. The day-to-day cleanliness of the laboratory is the responsibility of those working in it. Only when the Safety Officer has confirmed that it has been disinfected can other cleaning / maintenance work be carried out.
12. At the end of a working day benches and working surfaces should be disinfected.
13. Work with specified animal pathogens must be kept separate at all times from other work in the laboratory.

Handling of specimens

1. All in-coming packages which may contain specified pathogens must be opened by trained staff in the laboratory.
2. Senders should be advised that a liquid sample should be externally identified and sealed in a can filled with sufficient absorbent material wholly to mop up a spill. The can may, if necessary, be cooled in solid carbon dioxide or liquid nitrogen. Similarly solid samples should be double wrapped so that, in the event of the outer container rupturing, there can be no leakage of contents.
3. Chapter 6 of "Laboratory-Acquired Infections" by C H Collins (4th edition, Butterworth and Co. 1999) gives general advice on packing and unpacking specimens, but in the present context all such unpacking must be carried out in the containment facility.
4. Particular care must be taken when biological material which cannot be autoclaved, is to be removed from the laboratory. The Safety Officer must be consulted before unsterilised material is removed. Precautions must be taken to sterilise the outer surface of containers and to sterilise the material itself, as far as possible.

5. The movement of specified pathogens from an approved laboratory to any other premises is prohibited except under the provisions of a licence issued by DEFRA.

Security

1. It is imperative that the laboratory and animal rooms must be secure against intruders or vandals. An intruder alarm system must be fitted.
2. Security patrols, etc. must not enter laboratories, or animal rooms. If it appears that an adjacent fire or water hazard threatens the room then the Safety Officer should be informed immediately.
3. A key to the laboratory should be held centrally for emergency access but must only be released on the instruction of the Safety Officer or their deputy.
4. The Safety Officer must maintain a list of the specified pathogens used at the laboratory. This list must indicate the number of vials of pathogen under storage.

Standard operating procedures

1. SOPs must be written and issued to staff covering-
 - (i) receipt and unwrapping of incoming specimens;
 - (ii) handling of specified pathogens in vitro;
 - (iii) handling of specified pathogens in vivo (where appropriate);
 - (iv) disposal of all waste and surplus pathogens;
 - (v) storage of specified pathogens; and
 - (vi) emergency procedures.
2. All staff must be familiar with these SOPs and have access to them on a day to day basis. Adherence to the SOPs will be a condition of a licence issued under the Specified Animal Pathogens Order 1998 and they must not be altered without prior approval from the DEFRA licensing office. Any plans to amend SOPs must be forwarded, via the DEFRA inspector, to the appropriate HQ licensing office.

Animal room

NOTE: All relevant regulations in these Safety Precautions apply to any room in which animals are in contact with specified pathogens. There are, in addition, hazards arising from the natural diseases of animals which may be transmissible to man. Diseases can be contacted following bites, scratches, droplet infection or the bites of insect vectors. There are particular hazards associated with the generation of aerosols in animal rooms.

In addition to the staff utilising the animals, others may be engaged to clean and feed them (but see point 6 below) and the Safety Precautions also apply to them.

1. DRAINS: See THE LABORATORY - SITING AND STRUCTURE, paragraph 5.
2. DEAD ANIMALS, BEDDING, DUNG etc.: see LABORATORY FACILITIES, paragraph 2. Where autoclaving followed by incineration would create a radiological hazard, carcasses must be first sealed in a suitable bag.
3. CAGES AND ASSOCIATED EQUIPMENT: must be autoclaved or disinfected before being cleaned and returned to store.
4. ESCAPES: in no circumstances should there be a direct exit to the outside. The Safety Officer and the licensing authority of DEFRA must be informed if an animal

cannot be accounted for.

5. VERMIN: suspected or obvious infestation with insects or wild rodents must be reported at once to the Safety Officer and the licensing authority of DEFRA.

6. RESPONSIBILITY: servicing of specified pathogen rooms in the animal house must not be carried out by general animal house staff. Suitably trained staff approved by the Safety Officer should carry out these duties under the day-to-day supervision of the person in charge of the animal house.

Arthropods

See separate containment requirements for laboratories to be licensed to handle arthropods under the Specified Animal Pathogens Order 1998.

Animal Pathogens DEFRA Category 3

The requirements were amended in light of recommendation 47 [page 16] of the Health and Safety Executive's 'Final report on potential breaches of biosecurity at the Pirbright site 2007'.

SAPO Guidance issued can be found at <http://www.hse.gov.uk/pubns/priced/hsg280.pdf>

Containment Requirements for Laboratories to be Licensed to Handle DEFRA Category 3 Pathogens under the Specified Animal Pathogens Order 1998

(the requirements that are **over and above** those for DEFRA Category 2 Pathogens are listed below).

The laboratory - siting and structure

1. The laboratory should be isolated by an air lock. A continuous internal air flow must be maintained by one of the following means-

(a) extracting the laboratory air through independent ducting to the outside air through a HEPA filter;

(b) ducting the exhaust air from a microbiological safety cabinet to the outside air through a HEPA filter.

2. In laboratories which have a mechanical air supply system, the supply and extract airflow must be interlocked to prevent positive pressurisation of the room in the event of failure of the extract fan. The ventilation system must also incorporate a means of preventing reverse air flows.

3. The laboratory must be sealable so as to permit fumigation.

Laboratory facilities

1. The laboratory must be equipped with a Class I, II or III exhaust protective cabinet. All laboratory manipulations with live pathogens may be carried out with the cabinet in any mode with the exception of homogenisation which should be carried out with the cabinet in the Class I or III mode.

2. All waste biological material must be sterilised prior to removal from the laboratory. Therefore, each laboratory should have **direct** access to an autoclave. There should

be no possibility of removing the load without the autoclave cycle having been completed. As soon as practicable after the completion of the autoclave cycle the load should be taken to an incinerator and immediately incinerated. Autoclaves should be monitored to ensure that time / temperature cycles are completed and records should be kept.

Protective clothing

As for DEFRA Category 2 pathogens.

Safety Officer

As for DEFRA Category 2 pathogens.

Training in handling specified pathogens

As for DEFRA Category 2 pathogens.

Supervision

As for DEFRA Category 2 pathogens.

Laboratory discipline

1. The laboratory must be entered through a 'clean-side' changing area (locker room) separated from the 'dirty-side' by an airlock. All clothing, rings, watches, etc. must be removed into a locker. No food, drink, tobacco, make-up, etc. may be taken through the airlock. Clean protective clothing should be put on. The 'clean' and 'dirty' areas should be clearly distinguished physically.
2. On the way out, over garments should be removed on the 'dirty-side' of the airlock. The individual must then wash hands, transfer to the 'clean-side' and dress.
3. This procedure should be adhered to whenever, and for whatever purposes, when the room is vacated.
4. Periodically, the rooms and everything in them must be fumigated with gaseous formaldehyde.

Handling of specimens

As for DEFRA Category 2 pathogens.

Security

As for DEFRA Category 2 pathogens.

Standard Operating Procedures

As for DEFRA Category 2 pathogens.

Animal room

As for DEFRA Category 2 pathogens.

Arthropods

As for DEFRA Category 2 pathogens.

Prevention of Blood-borne Infections

1 Introduction

Viruses which may be transmitted by inoculation injuries involving blood and certain other body fluids include hepatitis B virus, hepatitis C virus and the Human Immunodeficiency Virus (HIV).

The procedures outlined in this document are designed to, as far as reasonably practicable, minimise the risks of infection.

2 Legislation

The Control of Substances Hazardous to Health Regulations 2002 (COSHH) (as amended), specifies the control measures to be applied in all occupations for preventing and minimising the risk of illness associated with exposure to biological agents at work. These requirements have always been implicit in sections 2 & 3 of the Health and Safety at Work Act etc 1974 (HSWA). The categorisation of biological agents has the status of law as it is an "Approved List" made under section 15 of the HSWA. Both HIV and Hepatitis viruses are listed in ACDP Hazard Group 3 (except hepatitis A, hazard group 2).

The requirements of the Management of Health and Safety at Work Regulations (MHSWR) 1999 overlap with other health and safety legislation including COSHH and the Genetically Modified Organisms (Contained Use) Regulations 2014 (as amended).

Where this occurs, compliance with the duty in the more specific regulations will normally be sufficient to meet the corresponding requirement of MHSWR.

3 Definitions

High Risk body fluids:

- i. Blood, amniotic, pericardial, peritoneal, pleural, synovial, cerebrospinal fluids, semen and vaginal secretions.
- ii. li Any other body fluid which is visibly blood-stained.

Contamination incident involving blood or a high risk body fluid:

- Accidental inoculation, commonly known a "sharps incident" or "needle-stick injuries" where a needle or another sharp instrument penetrates the skin. Transmission is also possible through a bite that breaks the skin.

- Contact of a high risk body fluid with broken skin such as a cut or an abrasion, with a mucous membrane or with an eye via a splash. Although intact, healthy skin is a good defence, skin affected by disease, such as eczema, may not be.
- Swallowing blood contaminated secretions, e.g. during mouth-to-mouth resuscitation without any airway or face shield.
- Severe contamination of clothing such that a change of clothing is required.

Recipient: Staff member sustaining the injury.

Source: Patient whose body fluids were involved in the incident.

Blood Borne Virus: Any virus, which may be transmitted from the blood of an infected carrier, e.g. HIV, Hepatitis C, Hepatitis B, HTLV-1.

4 Exposure-prone Procedures:

Exposure-prone procedures are those where there is a risk that injury to the worker may result in the **exposure of the patients' open tissues to the blood of the worker**. These procedures include those where the worker's gloved hands may be in contact with sharp instruments, needle tips and sharp tissues (spicules of bone or teeth) inside a patient's open body cavity, wound or confined anatomical space where the hands or fingertips may not be completely visible at all times.

Such procedures must not be performed by a health care worker who is either HIV or Hepatitis B e-antigen positive. The working practices of each infected health care worker must be considered individually and where there is any doubt, expert advice should be sought in the first instance from a specialist occupational health physician who may in turn wish to consult the Advisory Panel on infected health care workers.

Procedures where the hands and fingertips of the worker are visible and outside the patient's body at all times, and internal examinations or procedures that do not require the use of sharp instruments, are not considered to be exposure-prone provided routine infection control procedures are adhered to at all times including the wearing of gloves as appropriate and the covering of cuts or open skin lesions on the worker's hands.

The final decision about the type of work that may be undertaken by an infected health care worker should be made on an individual basis taking into account the specific working practices of the worker concerned.

See guidance for 'Exposure Prone Procedures' <http://www.hr.qmul.ac.uk/about-us/medical-and-dental-students/>

5 Risk Assessment

Heads of Departments, Schools or Institutes are responsible for ensuring that the risks of transmission of HIV in the context of the work of their Departments Schools / Institutes are fully assessed and understood. The primary method of prevention of transmission of blood-borne infectious agents is the adoption by all staff of safe systems of work (**see section 6 below**).

All departments / schools or institutes receiving human specimens must work within the guidelines in the HSAC publication "Safe working and the prevention of infection in clinical laboratories."

Heads of Departments / Schools or Institutes and those who supervise staff and students must ensure that work is only carried out subject to a written risk assessment (COSHH assessments already in place may be sufficient) and that adequate training and effective on-going supervision are given.

Employees who travel abroad in the course of their work should obtain from the QMUL Occupational Health Physician / Adviser specific advice about particular hazards that exist in countries to be visited and on precautions to be taken.

6 General Guidance on Safe Systems of Work

Safe systems of work will include the following general procedures:

- Apply good basic hygiene practices with regular hand washing.
- Cover existing wounds or skin lesions with waterproof dressings and wear protective, impermeable gloves.
- Avoid invasive procedures if suffering from chronic skin lesions on hands.
- Avoid contamination of person by appropriate use of protective clothing.
- Protect mucous membranes of eyes, mouth and nose from blood splashes.
- Take precautions to prevent puncture wounds, cuts and abrasions in the presence of blood.
- Avoid the use of sharps wherever possible and reduce the number of sharp items in the working area to the absolute minimum.
- Never re-sheath needles. Always dispose of needles directly into sharps bins. Other sharps must be disposed of using approved procedures.
- Always keep fingers behind the needle when handling infectious material.
- Use safe procedures for handling and disposal of needles and other sharp items.
- Use approved procedures for sterilization and disinfection of instruments and equipment.
- Clear up spillages of blood and other body fluids promptly and disinfect surfaces.
- Use the agreed procedure for the safe disposal of contaminated wastes.

See <http://www.hse.gov.uk/pubns/hsis7.pdf> and <http://www.hse.gov.uk/healthservices/needlesticks/resources.htm> for further information.

7 Procedure in the Event of a Contamination Incident

- 7.1 A "sharps" or "needle stick" injury is one in which blood or body fluid from one person is inoculated into another on the point of a needle, scalpel or other sharp object. The major health risks to someone receiving a sharps injury are **Hepatitis B**, **Hepatitis C**, and **HIV** infection.
- 7.2 However, the following advice also applies to spillage of blood or body fluids on to skin, especially broken or eczematous skin, mucous membranes or the eye.
- 7.3 Inoculation/contamination incidents must be recorded in the QMUL MySafety Accident and Incident Reporting module <https://qmul.oshens.com/> and immediately reported for investigation and recording / follow up to the QMUL Health and Safety Directorate <http://www.hsd.qmul.ac.uk/contact-us/> and to the QMUL Occupational Health <http://hr.qmul.ac.uk/about-us/> (if significant telephone 0207 882 8700). (**See below for First Aid arrangements**).

7.4 The Health and Safety Directorate will investigate the circumstances and, if appropriate, report the incident to the HSE as required by the RIDDOR Regulations.

7.5 First Aid, Incident Reporting and Medical Help / Follow up

First Aid on site (at QMUL, call 0207 882 3333 if a local first aider is not available)

- 7.6 Encourage bleeding where skin is punctured.
- 7.7 Wash thoroughly with copious amounts of soap and warm water. DO NOT USE A SCRUBBING BRUSH.
- 7.8 If eyes are involved, wash immediately with water (use eye wash / plumbed-in eye / face wash / running tap water (or sterile water if tap water not available). If the mouth is contaminated, rinse with plenty of water.
- 7.9 Where massive contamination of unbroken skin has occurred, remove contaminated clothing and wash all affected areas with copious amounts of water.

See <http://www.hsd.qmul.ac.uk/a-z/first-aid/> for further details

Incident Reporting

- 7.10 Ensure that your line manager or immediate senior is informed promptly of the incident
- 7.11 QMUL Medical and Dental Students should report to the doctor or nurse in charge of the area where they are working.
- 7.12 The injured person (if able) or manager / immediate senior /first aider should complete an incident form (At QMUL - MySafety <https://qmul.oshens.com/>).

- 7.13 If on Barts Health NHS Trust premises, report incident into the Trust 'Datix' adverse events recording system. If on premises other than QMUL or Barts Health NHS Trust, report and record in the local accident book / log (if maintained).
- 7.13 QMUL has made an arrangement with the Occupational Health Service at the Barts Health NHS Trust for **injured medical and dental students** to receive immediate treatment from the Trust's Occupational Health service. The follow up will be provided by QMUL Occupational Health.

7.15 During working hours (08:30 to 16.30 Monday to Friday - normal work days)

After first aid, seek medical advice immediately:

a) QMUL Staff* during working hours (Monday to Friday 9am to 4:30pm) should call The QMUL Occupational Health Service on 020 7882 8700. Ground floor Geography Building Mile End. London. E1 4NS. occhealth@qmul.ac.uk

b) QMUL Medical and Dental students** during working hours (Monday to Friday 8.30am-4.30pm) should contact Barts Health NHS Trust Occupational Health Service. The Health and Wellness Centre. 31-43 Ashfield Street, Royal London Hospital, E1 2AH. Needle-stick line: 07745306654 (call this number BEFORE going to department). Reception: 020 3594 6609

**Staff from Containment Level 3 laboratories or if risk to individual is high and immediate should go to A&E with the risk assessment / data sheet.*

***QMUL Medical and Dental students on placement should contact the Occupational Health Service of the hospital they are working in.*

7.14 Out of working hours (16.30 to 08.30 Monday to Friday and at weekends / Bank Holidays / Closure days)

a) QMUL Staff outside of working hours should go to the nearest A&E department.

b) QMUL Medical and Dental students outside of working hours should go to the nearest A&E department.

7.15 Please be reassured that your case will be dealt with confidentially. All blood samples will be coded. Your identity will be known only to the Medical Virologist / clinician and Occupational Health Nurse dealing with your case.

7.16 QMUL Staff / Students who suffer a contamination incident when they are **not** in QMUL or Barts Health NHS Trust premises must follow the local procedure and report the incident to QMUL Occupational Health at the earliest opportunity on 020 7882 8700.

See

http://www.hsd.qmul.ac.uk/media/hsd/documents/QMUL_HS_124_Procedure-in-the-event-of-a-contamination-incident_V3_15.06.2018.pdf

8 Work with HIV and Hepatitis Viruses in Laboratories and Biological Service Units

Heads of Departments / Schools or Institutes are responsible for ensuring that the risks of transmission of HIV and Hepatitis in the context of the work of their departments / institutes are fully understood and the requirements of COSHH are complied with.

8.1 Research projects using human blood or other tissue samples should not use material from known HIV sources unless this is essential for the project and is preceded by a full written risk assessment. No programme of work that involves the propagation of HIV must be started until the Health & Safety Executive have given approval for the containment system to be used.

8.2 The elements of COSHH 2002 (as amended) as they relate to work with biological agents are:

- risk assessment;
- prevention of exposure or substitution of an agent with one that is less hazardous (where the nature of the activity permits);
- selection of control measures including appropriate immunisation if available;
- maintenance, examination and test of control measures including, for example, protective equipment such as safety cabinets;
- provision of information, instruction and training for employees;
- keeping a list of employees exposed to agents in ACDP Hazard Group 3;
- notification of first use of biological agents in ACDP Hazard Groups 2 and 3;
- Notification of the consignment or importation of biological agents listed (ACDP HG 4 agents) in Part 6 of Schedule 3 of COSHH; (*note* – QMUL does *not* have a license or the facilities to receive, handle or store ACDP HG 4 agents).
- monitoring exposure at the workplace (if there is a suitable procedure);
- Health surveillance of employees (where it is appropriate and if there are valid techniques for detecting indications of disease) when it can lead to action that will be of benefit to the employees.

8.3 Selection of Appropriate Containment Measures

Where agents classified in ACDP Hazard Group 3 are to be used, prior consultation with the Health and Safety Executive, the QMUL Biological Safety Adviser should occur to ascertain containment requirements.

The level of containment selected after a risk assessment should correspond with the hazard grouping of the biological agent i.e.: containment level 3 unless a particular strain of a biological agent is known to have reduced virulence, in which case containment level 2 may be used.

There may be uncertainty about the presence of HIV and Hepatitis in the samples to be tested. Where there is a strong indication or likelihood that specimens or samples may contain HIV or Hepatitis then additional control measures may be required. Revised guidance has been issued by the Department of Health in conjunction with the ACDP, for the handling and propagation of tissue and cell samples at risk of containing blood borne viruses.

http://www.acgs.uk.com/media/990069/acdp2_dh_suppl.pdf

The requirements of containment levels 2 & 3 for laboratories and animal rooms are listed in Procedure / Guidance Notes B05 & B06 above.

8.4 All departments / institutes receiving human specimens must work within the guidelines in the Health Services Advisory Committee publication, Safe Working and the Prevention of Infection in Clinical Laboratories, (HSAC) 2003 (ISBN 07176 25133) <http://www.hse.gov.uk/pubns/clinical-laboratories.pdf> .

8.5 There is detailed guidance on blood borne viruses in Protection Against Blood-borne infections at Work-HIV and Hepatitis, <http://www.hse.gov.uk/biosafety/diseases/bbv.pdf> and <http://www.hse.gov.uk/biosafety/blood-borne-viruses/risk-healthcare-workers.htm>

8.6 Safe Disposal of Waste

All forms of waste are categorised in law and there is specific legislation for the means of safe storage and disposal of substances hazardous to health. A biological agent (and thereby anything contaminated by a biological agent) which creates a hazard to health of any person is a substance hazardous to health.

Such waste containing HIV or Hepatitis is classified as clinical waste unless it is treated under controlled conditions that ensure that it has been rendered free from hazard. Hazardous waste containing HIV and Hepatitis must be disposed of using the College system for clinical waste.

See documents at <http://www.hsd.qmul.ac.uk/a-z/hazardous-waste/> for further details.

8.7 Transport of Biological Agents

There are various regulations concerning the transport of biological agents by post, road, rail, sea and air. These must be complied with. See <http://www.hsd.qmul.ac.uk/a-z/transport-of-dangerous-goods/> for further details.

9 Further guidance is available in the following publications:

Protection against blood-borne infections in the workplace: HIV and Hepatitis, ACDP
<http://www.hse.gov.uk/biosafety/diseases/bbv.pdf>

Revised Advice on Laboratory Containment Measures for work with Tissue Samples in Clinical Cytogenetics Laboratories, ACDP 2001 (supplement to 'Protection against blood-borne infections in the workplace: HIV and Hepatitis').
http://www.acqs.uk.com/media/990069/acdp2_dh_suppl.pdf

Safe Working and the prevention of infection in clinical laboratories and similar facilities, HSAC 2003. ISBN 07176 25133. <http://www.hse.gov.uk/pubns/clinical-laboratories.pdf>.

Biological agents: Managing the risks in laboratories and healthcare premises, ACDP 2005. <http://www.hse.gov.uk/biosafety/biologagents.pdf>

Working safely with research animals: Management of Infection risks, 1997, HSE. ISBN 0717613771 <http://www.hse.gov.uk/pubns/priced/animal-research.pdf>

The Management, design and operation of microbiological containment laboratories, ACDP 2001. ISBN 07176 20344.
<http://www.hse.gov.uk/pubns/priced/microbiologyiac.pdf>

Microbiological Safety Cabinets

1. Introduction

Aerosols generated when handling microorganisms and other biological materials represent a potential source of infection to all in the vicinity of the work. To protect against infection a microbiological safety cabinet (MSC) is used when infectious substances are being handled.

To provide adequate protection three key elements must be considered:

Choice of a suitable cabinet

Satisfactory performance of the cabinet when placed in the laboratory

Correct use of the cabinet

A MSC is a ventilated enclosure designed to protect the user and the environment from aerosols generated when handling hazardous biological material. Air discharged from the MSC to atmosphere passes through a high efficiency particle absorption (HEPA) filter to remove contaminants.

MSCs **must not** be confused with laminar flow cabinets. Laminar flow cabinets do not provide operator protection; they are designed to protect the work **only**. Laminar flow cabinets can be used only for animal derived material or tissue that is known to be non-pathogenic and non-allergenic. They cannot be used with human material or tissue.

There are three types of MSC that differ in mode of operation and level of protection provided:

CLASS I Microbiological Safety Cabinets

Class I have a front aperture through which the operator can carry out manipulations. The operator is protected by an inward flow of air through the front aperture but it is possible for some airborne material to escape.

This type of cabinet does not protect the work from external contamination.

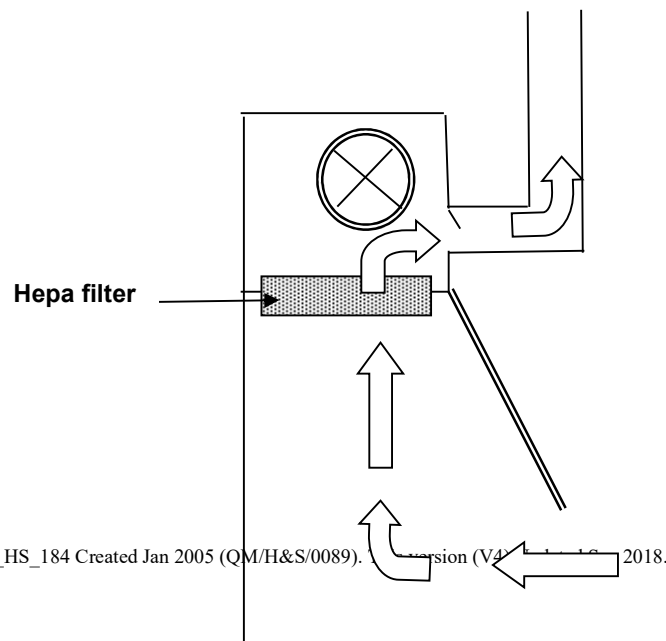

CLASS II Microbiological Safety Cabinets

Like Class I cabinets, Class II cabinets have a front aperture through which the operator can carry out manipulations and again some airborne material can escape. The cabinet gives the operator protection but is also designed to protect the work being undertaken from contamination from external contamination. This contamination protection is achieved by directing air drawn through the front aperture downwards into a plenum below the work surface. Some of this air is filtered before being redirected into the working area as a laminar down flow of clean air to protect the work from external contamination. The balance of this laminar down flow with the incoming air provides an air curtain at the front aperture, which provides the operator protection. With correct installation and use modern Class II MSCs give a similar operator protection to Class I cabinets.

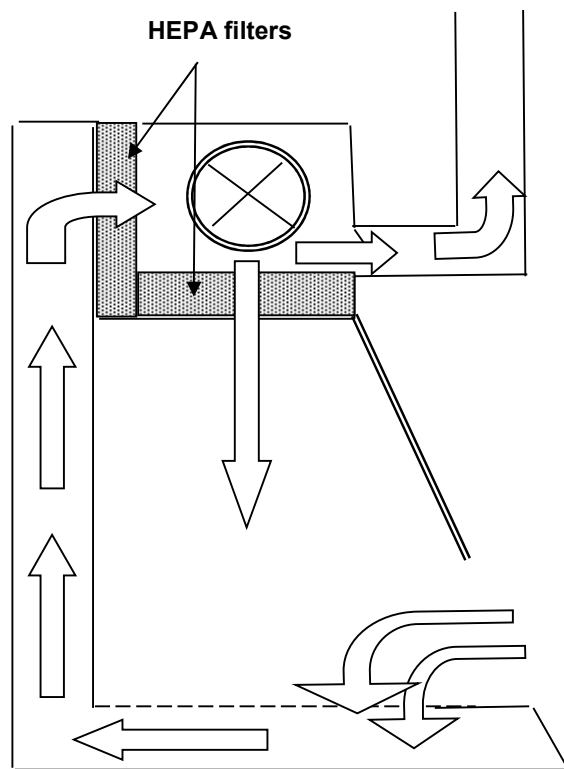

CLASS III Microbiological Safety Cabinets

Class III cabinets have a totally enclosed working area that prevents release of airborne material. This design provides maximum protection for the operator and for the work. Access to the cabinet is through arm length gloves attached to ports in the front panel. Air drawn into the cabinet is HEPA filtered, and the working chamber is under negative pressure.

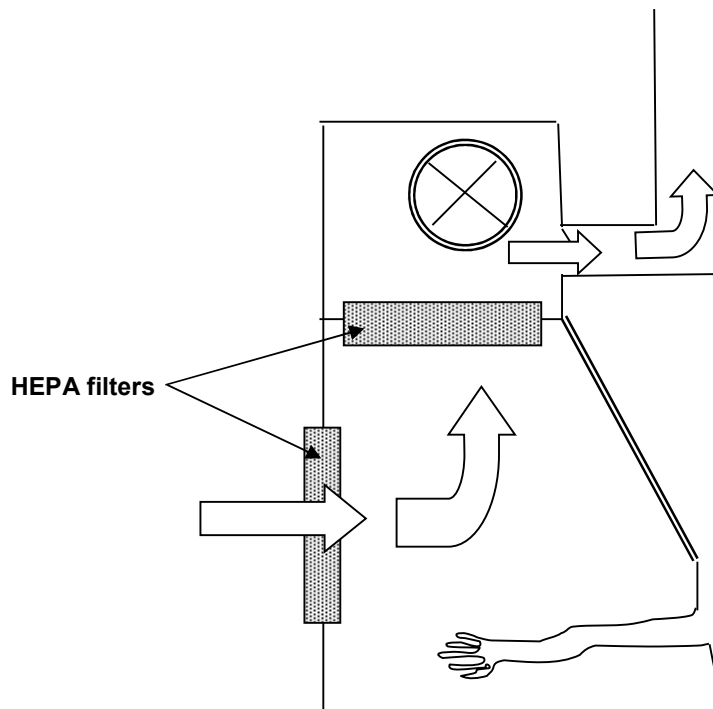

2 Selection of MSC

2.1 General guidance is available in ACDP publication 'The Management, design and operation of microbiological containment laboratories' and other specialist publications (available from the University Safety Advisers).

2.2 Departments/Schools/Institutes/Centres may contact the University Safety Advisers for advice concerning types and models prior to placing a firm order.

The choice of MSC depends on a risk assessment that considers:

- Properties of micro-organisms to be used including their route of transmission, infectivity, survival in environment, and susceptibility to disinfectants,
- Nature of the work e.g. is significant aerosol generated?
- Is protection of the work from contamination required?

2.3 In most cases the following will apply:

Containment Level 1 and 2 laboratories

A Class I MSC should be used unless protection of the work is required, when a Class II MSC may be used which gives an adequate operator protection factor (see section 3 below).

Containment Level 3 Laboratories

A Class I should be used:

- If the micro-organism or Genetically Modified organism has an airborne route of transmission.
- If procedure generates significant aerosol (e.g. ultrasonic disruption).

A Class III MSC should normally be used with a micro-organism or GM micro-organism considered to be high risk e.g. multiple drug resistant strains of human respiratory pathogens.

A Class II MSC may be only used for work with:

- Hazard group 3 pathogen with derogation such that use of a MSC is not essential e.g. some blood borne parasites,
- Non-hazard group 3 pathogens that are assigned to containment level 3 under DEFRA restrictions e.g. some animal pathogens that do not cause harm to human health,
- Materials known or suspected of containing hazard group 3 agents when there is no cultivation or concentration of those agents,
- Blood borne viruses in hazard group 3 that are unlikely to be transmitted via the airborne route (e.g. HIV, Hepatitis).

2.4 A Flow chart to aid selection of a microbiological safety cabinet is shown on the next page:

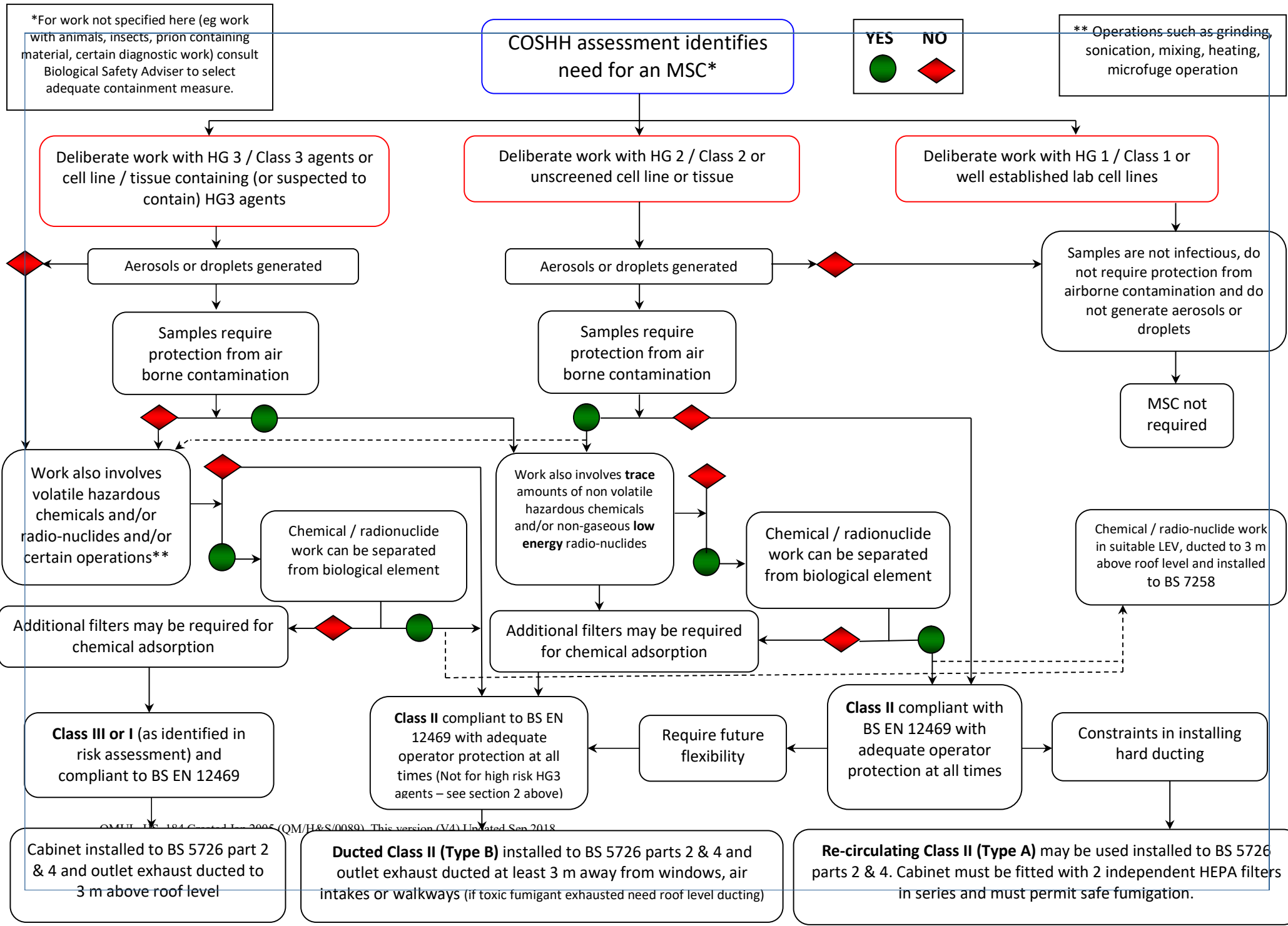

3.0 Commissioning

- 3.1 All cabinets must be installed and commissioned by a specialist contractor and must pass tests as specified in BS 5726:2005 (parts 2 and 4) and BS EN12469:2000. As the European standard does not cover all aspects of installation or commissioning of MSC's required under the Control of Substances Hazardous to Health, 2002 (as amended) Regulations (COSHH), BS5726:2005 parts 2 and 4 must also be referenced. In all cases, commissioning must include an **"operator protection test"** such as the potassium iodide (KI) disc test as defined in BS 5726:2005. Commissioning records and further test / repair records must be kept for at least 5 years as required by COSHH 2002 (as amended) Regulation 9.
- 3.2 **All subsequent defects must be reported** by the user to their supervisor immediately and the cabinet must **not** be used until repairs are made to return it to safe use.
- 3.3 **The operator protection test must be shown to be satisfactory under the conditions of use.** An "in-use" operator protection factor test must be carried out that mimics working conditions, e.g. a second operator must move around the laboratory, open and close the entry door and simulate normal working practices. All ventilation must be switched on for the duration of the test. As a best practice measure and to monitor performance, an operator protection test should be carried out at intervals not exceeding 14 months. When working with Hazard Group 3 organisms or with Hazard Group 2 organisms that are transmitted by the aerosol route, it may be appropriate to perform the test at more frequent intervals (eg every 6 months).
- 3.4 **In all cases, the use of a Class II MSC must be justified by a risk assessment since the operator protection given by this type of cabinet is highly dependent on correct cabinet placement, installation and use.**
- 3.5 At Containment Level 2, the current British Standard (BS EN 12469:2000, Performance criteria for microbiological safety cabinets) specifies only a single HEPA in the exhaust **with** the caveat that the **risk assessment may demand additional requirements. Within QMUL, it is recommended that all re-circulating Class II cabinets be installed with double HEPAs on the exhaust** to ensure they are suitable for work with all types of micro-organisms. This will need to be specified when the cabinet is ordered.
- 3.6 At Containment Level 3, re-circulating cabinets can only be used with some derogated Level 3 agents e.g. *Plasmodium falciparum* and air must be discharged through two HEPA filters. Where, by agreement with the University Safety Advisers, the MSC re-circulates into the workroom, suitable arrangements must be made for fumigation. This normally entails obtaining the suppliers "fumigation kit" and arranging for it to vent into a suitable ducted fume cupboard or another ducted microbiological safety cabinet.
- 3.7 Exhaust air from safety cabinets should be vented to the building roof where possible because this:
- Allows safe discharge of fumigant gas after decontamination,
 - Allows safe discharge of small amounts of volatile, toxic substances used to treat cultures,
 - Provides an additional safety margin in event of filter failure,
 - Provides an inexpensive and simple method of maintaining negative pressure within a containment laboratory.

3.8 For MSCs with integral fans, the ductwork should be less than 2m and airtight. If the ductwork is longer than 2m then an additional exhaust fan should be located as near to the discharge point as possible.

3.9 Any external exhaust duct must be at least 3 metres from any window, ventilation opening or walkway. A cowl at the exhaust outlet may be required to prevent back flow. Ducting exhaust at ground level is not advised for work with volatile / toxic chemicals and radio-nuclides.

3.10 Recommended positioning of a MSC in a laboratory

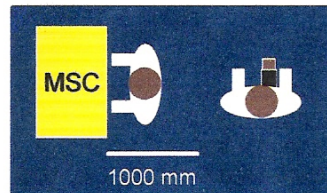

Keep pedestrian traffic away from the front of the MSC

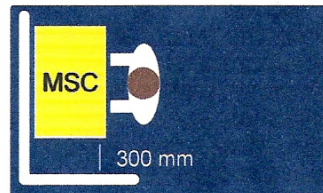

Keep clear of adjacent wall

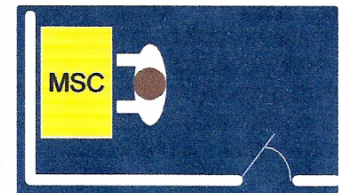

Keep clear of door openings

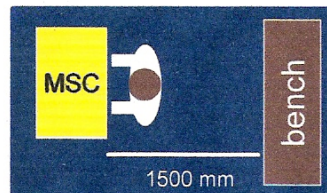

Position clear of bench opposite

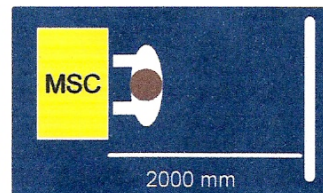

Position well clear of wall opposite

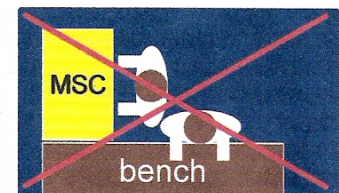

Do not have another worker at an adjacent bench

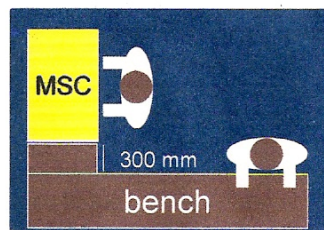

Allow adequate room for workers at nearby benches

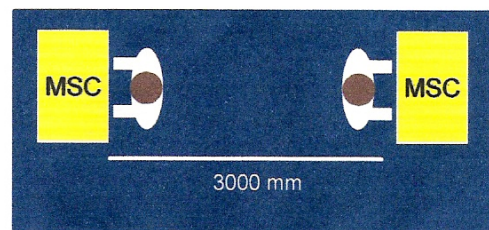

Keep well clear of safety cabinet opposite

4.0 Use

4.1 Any Existing Class II Cabinets which re-circulate through **one HEPA filter**:

These units must **NOT** be used for work with:

Known pathogens of **ACDP Hazard Group 2** or higher

Human tissue assigned to **ACDP Hazard Group 3**

Blood-borne agents such as HIV and Hepatitis B.

Subject to a suitable risk assessment, they **MAY** be used for work on human material.

Note that continuous use of these units, is subject to a satisfactory risk assessment whenever there is a significant change in the work taking place, and suitable arrangements must be made for fumigation (e.g. use of the suppliers "fumigation kit").

5.0 Preparation for Servicing and Testing

5.1 Cabinets used for known ACDP Hazard Group 2 pathogens

Routine access and testing: Swab down all interior surfaces with a validated and suitable **disinfectant solution**.

Dismantling and/or removal of filter require prior fumigation with **formaldehyde** or **another agent validated to decontaminate (see section 8.0 below)**.

5.2 Cabinets used for known Hazard Group 3 pathogens

Access testing and maintenance by anyone other than persons officially designated in the laboratory access protocol requires **formaldehyde fumigation** or **another validated fumigating agent (see section 8.0 below)**.

5.3 Cabinets used for Human Tissue Culture

The same procedures should be observed as for cabinets used for known pathogens.

6.0 Training

6.1 It is the Head of School / Department / Institute / Centre's responsibility to ensure that users are adequately trained to carry out the procedures referred to in this guidance note.

No one should be allowed to use a MSC unless they have demonstrated competence.

6.2 Trained users must understand:

- Classification of cabinets
- Principles of airflow and operator protection factor tests
- Limitations of performance
- Appropriate and inappropriate use of MSCs
- Mode of operation and function of all controls and indicators
- How to work at cabinets safely
- How to decontaminate after use

7.0 Fumigation of Microbiological Health and Safety Cabinets

7.1 This Section should be read in conjunction with BS EN 12469:2000 (available for reference from the Health and Safety Directorate).

7.2 Except in those cases where hazardous material has not been used, fumigation of microbiological safety cabinets is necessary:

- before testing
- before filters are changed
- before maintenance work to (potentially) contaminated parts of the cabinet
- after spillage of infectious material

and also at regular intervals which must be assessed according to the use to which the cabinet is put. It may also be necessary to decontaminate equipment or materials before they are removed from the cabinet.

7.3 A '**Permit to Work**' form must be completed before testing or servicing is carried out. This will indicate to an external person (eg a service / testing engineer), the contamination status of the equipment and any safety measures required to be in place before the activity is conducted.

7.4 Formaldehyde vapour is most often used but it has limitations. It penetrates poorly and its effectiveness depends upon the temperature and humidity (see Procedure / Guidance Note B13). The vapour can also combine with many common substances and under certain conditions will readily polymerise. Use of excessive amounts may cause deposition of polymers in the cabinet and may contribute to filter blockage.

7.5 Vapour can best be generated by evaporation of formalin from a proprietary formalin vaporiser. Formalin liquid may also be evaporated by a thermostatically controlled hotplate. Commercially available fumigation kits can also be used and the manufacturer's procedure must be followed.

Note: The addition of formalin / formaldehyde to potassium permanganate should NOT be attempted as control of the violent reaction is difficult.

7.6 Commercial formalin contains varying amounts of methanol. Formaldehyde vapour is explosive at 7.75% concentration in dry air. Formaldehyde is **toxic by inhalation, contact with skin and if swallowed** (Risk phrase R23/24/25), causes **burns** (R34), has (limited) evidence of a **carcinogenic effect** (R40) and may cause **sensitization** by skin contact (R43). The Work Exposure Limit (WEL) is 2ppm (or 2.5 mg m⁻³).

Persons carrying out fumigation should have a face mask approved and fitted for use against formaldehyde and should not work alone.

Formaldehyde vapour is most effective at a relative humidity of 65% and a temperature above 24°C. A concentration of at least 0.05g of formaldehyde per m³ of airspace should be achieved.

7.8 The MSC should be sealed before the formaldehyde is generated inside the cabinet. The temporary closure panel (night door) should be sealed using security tape or similar over the gaskets to reinforce the seal. The seal can be tested by switching on the cabinet fans which should indicate 0.00 m/s face velocity after 5 - 10 seconds of operation. The manual damper of the cabinet must be closed shut. Some cabinet models automatically close the dampers when the fumigation function is activated. Always, consult the manufacturer's instructions and follow the procedure specified.

7.9 Attach an approved warning sign on the front of the cabinet "TOXIC GAS - FORMALDEHYDE" and on the door to the laboratory "TOXIC GAS". An example (in accordance with the Health and Safety (Safety Signs and Signals) Regulations 1996 (as amended), is shown below.



7.10 With recirculation type cabinets, a fumigation vaporiser should be used (this may be integral to the cabinet or a standalone unit which must then be placed inside the cabinet). Formalin stocks must be handled (eg dispensing formalin into the vapouriser) inside a suitable local exhaust ventilation system (eg fume cupboard).

Quantities required for formalin evaporation method		
Cabinet	Amount of BP formalin	Amount of water
Class I	20 ml	20 ml
Class I/III hybrids	20 ml	20 ml
Class II (1200 wide)	25 ml	25 ml
Class II (900 wide)	20 ml	20 ml
Class II (1800 wide)	30 ml	30 ml
Class III	20 ml	20 ml

7.11 Alternatively, a commercial supplier's fumigation kit may be used following the manufacturer's procedure. Any procedure that does not adhere to the required EN BS standards must be brought to the attention of the University Safety Advisers before use.

7.12 During the formalin boiling phase the cabinet fans may be briefly run for 10 seconds or so on a couple of occasions to assist in the dispersal of the gas – ideally, this should be done remotely. When all the formalin has evaporated (20-30 minutes) the unit should be switched off and left sealed overnight or a minimum of 6 hours (this time may be reduced in emergencies under very strict and controlled conditions with required PPE and monitoring equipment in place).

7.13 The laboratory door must now be locked so that any unauthorised person cannot gain entry.

7.14 Following decontamination, the MSC must be purged of all residual formaldehyde. Cabinet dampers must be opened. Where validated, in-line charcoal / activated carbon filters may be used to assist with neutralizing formaldehyde vapour. With recirculation cabinets, the end of the flexible ducting should be placed in a suitable outlet, e.g. fume cupboard or a safe discharge outlet, and the shut-off valve opened. Extreme care must be taken not to discharge formaldehyde back into the laboratory or to any adjoining windows or ventilation inlets. The cabinet should be run for at least 20-30 minutes to allow any residual formaldehyde to be purged.

- Fumigation is best carried out at the end of a working day. Adjoining laboratories and offices should be notified and instructed to close their windows against any possible re-entry into the building of formaldehyde fume.
- Fumigated filters should be removed with required PPE and put into a polyethylene bag that is sealed for safe disposal.

7.15 MSC Fumigation Summary

- Dispense safely correct amount of formalin in vaporiser unit (integral or standalone) and replace cap.
- Put standalone vaporiser (or commercial fumigation kit) inside cabinet.
- Add required amount of water to vapouriser or kit.
- Seal up cabinet using tape to reinforce closure gaskets / night door.
- Switch on vapouriser. (Fans may be run briefly after 10-15 minutes).
- Leave overnight or for a minimum 6 hours.
- Open dampers and shut off valve in night door and switch on fans to exhaust fumigant.
- For re-circulating cabinets, attach flexible ducting to cabinet and outlet to safely discharge.
- After 10 minutes (non-recirculating cabinets), remove night door.
- After another 20 - 30 minutes, any flexible ducting can be removed; the cabinet can be opened and used.

8.0 Selection of Vapour Hydrogen Peroxide (VHP) Fumigation:

Currently, two methods are used -

(1) 'wet' method whereby a 'micro-condensation' of VHP is propagated without the need for a prior de-humidification step. Some safety issues have been raised regarding metal corrosion, peroxide breakdown by copper / brass and cellulose material and potential flammability hazard. A 'uniform layer' of micro-condensation may not be achieved.

(2) a 'dry' method whereby VHP is kept below the condensation point to achieve to propagate the vapour phase. A prior de-humidification step is required. It is claimed that this is safer than the 'wet' method with regard to flammability and corrosion and that better penetration is achieved.

The 'dry' VHP method is thought to achieve better penetration and uniform spread of fumigant with less unwanted side effects. For both wet and dry methods, pre-cleaning of soiled areas may be required to achieve efficient uniform penetration of VHP.

The VHP fumigation method **must be validated** (show a 6 log kill) for the biological agent used and with the process / work activity. Sealable attachment or openings for VHP generator hoses and sealable openings for a peroxide 'catalytic converter' attachment may be required for operation (attachments may be possible through the cabinet night door). Exhaust of fumigant is not required but VHP **must** be converted to harmless water and oxygen by the system before re-opening cabinet. Until converted to water and oxygen, hydrogen peroxide is harmful and an irritant. The relevant steps required for safe fumigation of cabinets noted in section 7 above must be followed.

See Guidance Note B12 for further information on VHP.

9.0 Provision of Gas

8.1 Bunsen burners or other naked flames must not be used in MSCs for the following reasons:

- Disturbance of airflow
- Fire risk
- Potential damage to filters

8.2 With open fronted cabinets the use of Bunsen Burners may reduce the operator protection by disturbing the airflows. They should never be used in Class II cabinets. Exceptionally, they may be provided for Class I cabinets but if so they should be low profile micro-burners equipped with a lever control to give full flame only as required, in order to minimise disturbance. To minimise the fire and heat damage, gas provision must be controlled via a solenoid valve, interlocked positively with the operation of the cabinet fans.

10.0 Routine Examination and Testing

9.1 Regular examination and testing according to BS EN 12469:2000 is required to ensure safety cabinets continue to provide operator protection. Minimum testing frequency by operators and service engineers and the required performance for Class I and II cabinets are given below:

Operator Tests

Test	Microbiological Safety Cabinet	
	Class I	Class II
Alarms/indicators	Before use	Before use
Face Velocity/ inflow	Monthly Velocity at all points should be between 0.7 and 1.0 m/s	Monthly Not less than 0.4 m/s

Engineer Tests

At Containment Level 3, all MSCs must be examined and tested **every 6 months**: all other cabinets must be tested and examined **at least annually**.

Test	Microbiological Safety Cabinet	
	Class I	Class II
Alarms/indicators	Function as specified	Function as specified
Face Velocity/ inflow	Velocity at all points should be between 0.7 and 1.0 m/s	Not less than 0.4 m/s
Down flow	N/A	0.25 – 0.5 m/s
Operator Protection Factor test	Greater than or equal to 1×10^5	
“in use” Operator Protection Factor test (if required)	Greater than or equal to 1×10^5	
Filter integrity	Overall efficiency greater than 99.95%	
Mechanical Integrity including visible ductwork	Intact	
Mechanical and electrical function	Function as specified	

References:

Maintenance, examination and testing of local exhaust ventilation, HSG 258, HSE Books, HMSO, ISBN 0 7176 1485 9.

BS EN 12469:2000. Biotechnology. Performance criteria for microbiological safety cabinets, ISBN 0 580 34869 5.

BS 5726 Microbiological safety cabinets – Information to be supplied by the purchaser to the vendor and to the installer, and siting and use of cabinets – Recommendations and guidance 2005. ISBN 0 580 45590 4.

Control of Substances Hazardous to Health (Fifth edition): The Control of Substances Hazardous to Health Regulations 2002 (as amended), Approved Code of Practice and Guidance, HSE Books, HMSO, ISBN 0 7176 2981 3.

Safety signs and signals: Guidance on Regulations - The Health and Safety (Safety Signs and Signals) Regulations 1996, HSE Books, ISBN 0 7176 0870 0.

The management, design and operation of microbiological containment laboratories, ACDP 2001, HMSO, ISBN 0 7176 2034 4.

Fumigation: Health and Safety guidance for employers and technicians carrying out fumigation operations. HSE Books 2005, HMSO, ISBN 0 7176 2999 9.

Procedure /Guidance Note B10

Safe Working Practices in Biological Laboratories

COSHH 2002 (as amended) Regulation 7 and Schedule 2A require that the 'good practice principles' be applied to adequately control exposure to a substance hazardous to health when it is not reasonably practicable to prevent exposure.

The 'good practice principles' are:

- 1 Design and operate processes and activities to minimise emission, release and spread of substances hazardous to health.
- 2 When developing control measures, take all relevant routes of exposure into account (ingestion, inhalation, skin absorption / contact, inoculation).
- 3 Use measures that are proportionate to the health risk.
- 4 Use control measures that are the most effective and reliable.
- 5 Where adequate control cannot be achieved by other means, provide suitable personal protective equipment in combination with other control measures.
- 6 Check and review control measures for their effectiveness.
- 7 Inform and train all employees on the hazards, risks of substances and use of control measures to minimise risks.
- 8 Control measures must not increase the overall risk to health and safety.

Good practice principles are reflected in good microbiological, occupational hygiene, containment (see Guidance Notes B04 – 06) and safe working practices in biological laboratories. The HSAC publication 'Safe working and prevention of infection in clinical laboratories and similar facilities' details these practices which are briefly described below.

Containing biological agents:

Operations creating aerosols or droplets such as vigorous shaking, mixing, or ultrasonic disruption must be conducted in a suitable microbiological safety cabinet (see Guidance Note B09) or other equipment that can contain the aerosol / droplet and eliminate inhalation.

Good Microbiological Practice and aseptic techniques

Good microbiological practice and aseptic techniques should be used to prevent aerosol generation and cross contamination of work and the workplace.

Examples of aseptic techniques:

Keeping vessel closed except for the minimum time required to introduce or remove material.

Manipulation techniques that minimise cross contamination such as opening lids with the little finger so they are not placed down on benches.

Eliminating casual contact with sterile consumables and immediately disposing or decontaminating after use.

If Bunsen burner and flame are used, flaming the opening of the vessel when tops are removed (prevents contaminated particles falling into vessel by upward current of hot air).

Examples of some Good Microbiological Practices:

Using techniques that minimise the possibility of producing aerosols:

Mix by gentle rolling and swirling rather than vigorous shaking (avoid frothing).

Pipette by putting the tip into a liquid or onto a surface prior to gently ejecting the pipette contents (to avoid bubbling and splashing);

Have vessels in very close proximity when transferring liquids between them (to avoid falling drops splashing);

Use loops only after they have cooled down after flaming (to avoid sizzling);

Not over-filling centrifuge pots (to avoid leakage into centrifuge) – avoid filling more than three-quarters of the pot.

Carry and store cultures etc (bottles and plates) in racks or other containers (to avoid accidental dropping and smashing).

Conducting purity / sterility checks of media and cultures. These checks also evaluate workers competence in microbiological techniques and lab practices.

An important aspect of good microbiological practice that often gets overlooked by the non-specialist is that experienced microbiologists handle **all** micro-organisms and cultures as if they are pathogenic.

Personal hygiene

One of the main routes of laboratory-acquired infections is by hand to mouth (ingestion). Therefore, hand washing is of primary importance and is essential

before leaving the laboratory. Hot water and soap is the best method for hand washing.

Contact between hands and face must be avoided in the laboratory.

Eating, drinking, smoking and applying cosmetics are prohibited.

Mouth pipetting, licking labels, chewing pens and finger nails, biting to open bags, holding objects between teeth, licking fingers to wet things must be avoided.

Before work all cuts, wounds and skin abrasions and dermatitis should be covered with water proof dressings and appropriate personal protective equipment. Barrier creams do not provide sufficient protection.

Hands must be disinfected and/or washed immediately when contamination is suspected and after infective material is handled.

Laboratory discipline

Only have on the bench those items necessary for the task in progress (avoid unnecessary clutter which would increase the likelihood of things getting knocked over and also to minimise the problems of cleaning up in the event of a spill);

Plan and lay out work so that everything needed for an experiment is ready to hand (this should allow the worker to sit at the bench and work comfortably);

At the end of each experiment tidy and disinfect / clean the bench.

In the event of spillage etc always disinfect / clean it up immediately and wash hands;

Avoid putting anything on the floor (to avoid tripping hazards and minimise the problems of cleaning up in the event of a spill);

Regularly clean out water baths (to minimise microbial contamination in the water);

Regularly clean down open shelving, benching, window-sills etc and items on them (to prevent build up of dust and debris, store infrequently used items in cupboards and drawer);

Regularly clean floors (to prevent build up of dust and debris, particularly in areas that are difficult to get to);

Regularly sort through items stored in fridges and freezers, on shelves and benches etc and safely dispose unwanted items (to prevent clutter);

Keep sinks clean (ideally, hand wash basins and taps should be cleaned daily).

Designating areas in the laboratory for storage of items at different stages in use cycles, and where appropriate, using visual systems (eg autoclave tape) for indicating status:

eg: clean/clean awaiting sterilisation/clean and sterile ready for use/used not decontaminated/used being decontaminated/used and ready for wash up (these types of systems allow for compartmentalisation of work activities into clean and dirty areas);

Everyone in laboratory to be aware of system to ensure no mix ups occur

The system should be logical and easy to follow in working practices (otherwise it won't work).

Personal Protective Equipment

Where exposure cannot be controlled by elimination, substitution, engineering controls / isolation or re-design of task, then suitable and appropriate personal protective equipment must be supplied to offer the necessary level of protection. This is the last line of defence against exposure to biological agents in the laboratory!

Laboratory gowns or coats should have long sleeves and afford protection when worker standing or seated. Gowns or coats with side or back closures, close fitting cuffs and quick release studs or fastenings should be used for higher containment laboratories.

Laboratory coats should be removed when leaving the laboratory and left close to the exit. They must not be taken to personal lockers or taken home.

Laboratory coats should be flame retardant that resists shrinking when autoclaved. In higher containment laboratories, laundering should be done after coats have been autoclaved.

Disposable gloves must be worn where there is a risk of contamination. The risk of latex sensitisation must be taken into account when selecting gloves. Various sizes should be available in the laboratory. Used gloves must not be re-worn as the risk of contamination increases.

Two pairs of disposable gloves can be worn when handling samples (minor damage to thin gloves often goes undetected until skin contamination is noticed).

Suitable and appropriate eye protection must be worn in all QMUL laboratories, unless a risk assessment shows otherwise. Contaminated eye protection should be thoroughly cleaned and disinfected before re-use.

Use of sharps

Avoid using sharps wherever possible. If this is not feasible then handling procedures should be designed to minimise the likelihood of puncture wounds and inoculation. Wherever possible, glass items (including glass pipettes) should be replaced with plastic alternatives.

Used sharps should be placed directly into a sharps bin. Sharps / equipment should not be put down and transferred later as this increases the risk.

Unless safe means have been introduced, needles should not be re-sheathed.

Sharps bins should not be overfilled, used sharps protruding from bins are very dangerous for those who have to handle them.

The term sharp should be taken to refer to any item that is sharp and not be restricted to needles and scalpels. Commonly used items that could easily cause damage to the skin include all glass items (including microscope slides and cover slips), ampoules, pointed nose forceps, dissection instruments, scissors, wire loops that are not closed circles and gauze grids used in electron microscopy work. This list is not exhaustive and all items should be assessed for sharp edges. Cracked and chipped glassware should always be discarded immediately.

Disinfection and waste disposal

This is addressed in Guidance Notes B12 – B14 and <http://www.hsd.qmul.ac.uk/a-z/hazardous-waste/>

Main reference:

Safe working and the prevention of infection in clinical laboratories and similar facilities. HSAC 2001, HSE Books ISBN 0 7176 2513 3.

Centrifugation of Biological Material

Risks from centrifugation of biological material

The degree of risk in the centrifugation of biological material will depend on a number of factors such as infectious nature of the material, the type of apparatus used, the volume of material handled and the care with which it is manipulated. Aerosols may be created during dispensing or siphoning of suspensions and supernatant. A heavy aerosol may be created in the event of a bursting or overflowing of a tube, or from a breakage due to a mechanical fault. Unless the material is confined, the procedure will be hazardous to the worker and others in proximity.

Safe operation of centrifuges with biological material

If blood, body fluids or microbial suspensions that present an infection risk are to be centrifuged, then sealed buckets or rotors **must** be used ('biosafe' centrifuges are recommended). After centrifugation the buckets or rotors should be opened in a microbiological safety cabinet in case a breakage has occurred.

The lid lock mechanism of the centrifuge must be sufficient to ensure that any fragments produced by any disruption are contained.

The loading of centrifuge buckets with ACDP Hazard Group 2 and 3 organisms (or material likely to contain them) **must** be carried out within a microbiological safety cabinet. The outside of these must be wiped with disinfectant prior to transfer from the cabinet to the centrifuge.

All buckets and tubes used for centrifugation should be inspected before use. They should be clean, matched with the corresponding bucket or tube, be free from corrosion and contain the necessary rubber cushions or insert adapters.

Rotor loads must be properly balanced and seated. Care must be taken to ensure that tubes in angle head rotors are not overfilled as this could lead to spillages when the fluid level changes in response to the centrifugal forces. Correct lifting techniques with any required mechanical assistance should be used when moving heavy rotors.

Any damaged / corroded rotors and buckets should be noted and removed from use. Rotors should not be used beyond their life-span. Seals and adapters should be replaced when signs of wear and tear are noted. Rotors and buckets should be cleaned and thoroughly dried after use and stored in a clean area.

The following points should be noted when selecting centrifuge tubes:

- i Compatibility of the tube with the rotor and specific density of the sample.
- ii Compatibility of tube with the rotor's maximum spin speed (or the maximum *g* force generated).
- iii Capacity of the tube or bottle, to prevent overfilling which may result leakage of the contents during centrifugation.
- iv Suitability for decontamination e.g. autoclave or chemical disinfection.
- v Density of the material and primary container compatibility.
- vi Glass tubes must not be used except in exceptional circumstances and never for Hazard Group 3 agents.

Consideration should be given to supervision of centrifuge until full acceleration to the operating speed has been achieved

Installation and maintenance of centrifuges

It is recommended to establish a minimum of a 300mm clear zone around the centrifuge; consult the manufacturer's guidance for specific requirements.

Centrifuges will disrupt airflow patterns in microbiological Class I and II cabinets. It is recommended to use bio-safe centrifuges in these cabinets to minimise disruption of airflow.

Bench centrifuges should be sited to ensure they will not fall off the bench in the event of an imbalance occurring whilst spinning.

Safe installation and connection to electrical supply – see relevant British Standard BS EN 61010-2-020: 1995, 'Safety requirements for electrical equipment for measurement, control and laboratory use: Particular requirements for laboratory centrifuges'.

Use centrifuges and rotors within manufacturer's recommended limits with respect of speed, Container type, Weight, Specific Gravity.

Comply with manufacturer's maintenance schedules and service programmes for tubes, trunions, spindles, bowls, pots and rotors including life span for rotors. Log records on usage for high speed centrifuges should be maintained and monitored to ensure management of life span. Service records should be retained.

Compatibility of disinfectants and cleaning agents with the centrifuge required to be disinfected should be checked (e.g. Chlorine based disinfectants will attack stainless steel and other metals, some plastics may be attacked by phenolic based compounds, quaternary disinfectants are inactivated or absorbed by some plastics).

Establish emergency procedures, with particular consideration to the duration of an isolation period after a breakage or suspected leak of any infectious

material, evacuation, transfer buckets and/or rotor to a microbiological safety cabinet, reporting of incident and decontamination of rotors and buckets appropriate to the nature of the hazard.

Training in the use of centrifuges

Laboratory workers should demonstrate competence through appropriate training before operating any centrifuge. Availability of manufacturer's operating instructions and visible aide memoirs of key operational points at each centrifuge can enable safe operation.

Types of laboratory centrifuges used for centrifuging biological material and indication of typical speeds and g force:

- 1 Ultracentrifuge: up to 150,000 rpm and 1,000,000g
- 2 Low Speed Floor Standing: 10,000 rpm and 15,320g
- 3 High Speed Floor Standing (operated with or without vacuum): 26,000 rpm and 70,000g
- 4 Micro Centrifuge: normally with fixed rotor up to 13,000 rpm and 16,000g
- 5 Bench Centrifuges which may have fixed or swing-out rotors: 300 rpm – 21,000 rpm and up to 49,555g

(Industrial centrifuges are not used for centrifugation of biological material at QMUL).

Sterilisation and Disinfection

Decontamination

The process of decontamination removes or destroys biological contamination to render an area, item or material safe to handle in the context of the material initiating infection or any other harmful response to humans and the environment. Different types and levels of decontamination are used according to the infectious nature of the biological material, the type of equipment / surface that holds / contains the material and the procedures that are conducted. COSHH¹ Regulation 7 requires that exposure to biological agents must be prevented or where this is not reasonably practicable, controlled by appropriate decontamination and disinfection procedures (amongst other measures).

1 Sterilisation

Sterilisation renders an item or area free from all living micro-organisms. As micro-organisms are killed according to logarithmic kinetics, a zero point is not measurable. Validation of a make safe process is therefore achieved by establishing a finishing point of 6 to 12-log reduction. This establishes a sufficient safety margin (at least a 6-log reduction) to ensure complete kill (this is termed the 'sterility assurance level').

1.1 Steam sterilisation

Sterilisation can be achieved by a number of methods of which steam sterilisation is regarded as the most effective for acting against the widest spectrum of biological agents including heat-resistant spores. As it is also a non-toxic, non-corrosive method and can be controlled by physical parameters to validate the process, it is the method of choice in laboratories for sterilisation. Direct contact between the material and pure saturated steam is required at the required temperature for the minimum required time in the absence of air to achieve complete kill.

Eg at 121°C – minimum holding time 15 min
 at 126°C – minimum holding time 10 min
 at 134°C - minimum holding time 3 min

Steam sterilisation and safe effective use of autoclaves to achieve steam sterilisation is detailed further in Guidance Note B14.

It should be noted that prion containing material is not inactivated by steam sterilisation conditions² and alternative methods must be used to decontaminate (see section 2 below and Guidance Note B17). Some medical and dental equipment may be susceptible to damage (eg rupture or fracture of equipment, incompatible material) to high pressure / vacuum and high temperatures and alternative methods may be required to sterilise the items.

Other methods of sterilisation

1.2 Dry heat (hot air)

This method is typically used for heat stable, non-aqueous items such as powders, waxes and non-aqueous liquids (eg oily injections, silicone lubricant), non-stainless metals and glass syringes. To achieve sterilisation, every item must achieve the required sterilising temperature for the recommended holding time (eg 160 - 170°C for 120 min, 170 - 180°C for 60 min or 180 - 190°C for 30 min). The efficacy of sterilisation depends on the initial amount of moisture present in the item / biological material. As the heat time, conductivity of heat and initial moisture of content varies widely for a load; this method is inefficient compared to steam sterilisation, time consuming and is difficult to repeat validated conditions.

1.3 Gas plasma

This method uses a highly active gas (eg hydrogen peroxide gas plasma at a low temperature) to generate ions, molecules and free radicals that are capable of inactivating biological material. It is a new and emerging technology that is not currently widely available. It purports to have a broad spectrum against micro-organisms and takes 1 to 2 hours to complete inactivation. Sterilisation of medical and dental equipment by this method has been noted in scientific literature. Use of gas plasma is not thought to create toxic end products. However, the hazardous nature of the gas must be evaluated before use (hydrogen peroxide is harmful by inhalation (WEL of 2 ppm short term exposure), causes burns and is explosive when heated). UV radiation may also be produced by gas plasma sterilisation chambers during the process.

1.4 Ethylene oxide gas / low temperature steam and formaldehyde

These methods use carcinogenic / toxic substances to sterilise medical and dental equipment (Workplace Exposure Limits (WEL)³ for ethylene oxide is 5 ppm long term exposure and 2 ppm for formaldehyde, both long and short term exposures). As exposure to these substances have severe health effects, these methods are generally not used. Ethylene oxide is highly flammable and explosive. Formaldehyde is also explosive at 7.75% in dry air. These methods must only be used under controlled conditions after careful risk assessment and consultation with safety experts.

1.5 Ozone

Ozone (O₃) is a powerful oxidiser and unstable (metastable) form of oxygen. It reacts with water to produce OH ions and free radicals which then inactivate micro-organisms by damaging cellular proteins, nucleic acids and lipids. Sterilisation of medical and dental equipment is purported to be achieved by this method and is dependent on the ozone dose given. Ozone is a toxic substance with a WEL of 0.2 ppm (short term) and causes lung irritation and damage. Ozone is also explosive at high temperatures and in the presence of

organic and combustible material. This method must only be used under controlled conditions after careful risk assessment and consultation with safety experts.

1.6 Formaldehyde fumigation: Gaseous (vapour) and liquid formaldehyde can achieve sterilisation under certain conditions. Formaldehyde inactivates micro-organisms by cross-linking (alkylating) cellular proteins and nucleic acids. Formaldehyde is a toxic carcinogen with a WEL of 2 ppm (short term exposure) and at all times must be handled under controlled and contained conditions. The advantages, disadvantages and procedures for using gaseous (vapour) formaldehyde fumigation are detailed in Guidance Notes B09 and B13.

1.7 Glutaraldehyde: Liquid glutaraldehyde (typically 0.5 – 2 % w/v) can achieve sterilisation under certain conditions. Glutaraldehyde is a potent skin and respiratory sensitiser and toxic substance with a WEL of 0.05 ppm. It is non-corrosive but does not penetrate organic matter readily and is unstable once activated. As exposure to glutaraldehyde causes severe health effects, it must not be used as a sterilisation agent unless there is no other alternative. This method must only be used under controlled conditions after careful risk assessment and consultation with safety experts.

1.8 Vapourised hydrogen peroxide: The broad antimicrobial action of hydrogen peroxide is attributable to its powerful oxidising ability. At the point of contact and in the presence of metal transition ions, hydroxyl radicals are generated which damage microbial proteins, nucleic acids and lipids. As hydrogen peroxide decomposes into harmless end products (oxygen and water), it is a less hazardous method than formaldehyde fumigation by not involving the use of a carcinogenic substance. However, hydrogen peroxide in itself is harmful by inhalation (WEL of 2 ppm, short term exposure), irritant to skin, eyes and mucous membranes and causes burns and therefore must be handled under controlled conditions.

For effective sterilisation by vapour hydrogen peroxide using a 'dry method', conditions should be controlled to ensure that vapour does not condense into liquid (typically, dehumidify to low relative humidity (30-40 %), temperature between 4 and 80°C with initial hydrogen peroxide concentrations of 0.3 – 5 mg / litre). When fumigating larger areas (eg laboratory rooms), heat tracing, insulation of hoses and aeration may be required to effectively keep hydrogen peroxide in vapour form. Using a 'wet method', a layer of hydrogen peroxide 'micro-condensation' is distributed over surfaces by gassing and aeration.

Using vapour hydrogen peroxide methods to sterilise is generally quicker (contact times of 1 - 3 hours) than formaldehyde fumigation. However, penetration of organic material by vapour hydrogen peroxide is poor and pre-cleaning may be required to increase efficacy.

1.9 Chlorine Dioxide: This chemical is used in a gaseous phase for sterilisation. It has a broad spectrum of activity but does not lead to the formation of toxic trihalomethanes and chloramines that chlorine can produce.

Gas is generated from a solid phase system and requires contact time of 1 - 2 hours with an effective concentration of 10 mg / litre. High relative humidity (>65%) is required for sporicidal validation but sterilisation can be conducted at ambient temperature. The gas is broken down rapidly by light and the process must therefore be protected from exposure to light.

Chlorine dioxide is also a very toxic substance with a WEL of 0.3 ppm (short term exposure) and can be explosive and therefore must be used in a controlled environment.

1.10 Irradiation: UV light at 260 nm can be used to sterilise chambers. Nucleic acids of organisms are broken or damaged. However, UV light has poor penetration and therefore may not achieve effective sterilisation. Spores and prion material are resistant to UV irradiation. UV resistant protection is required to protect workers.

Gamma irradiation is not generally used in laboratory environments but is used to sterilise consumables in industrial settings. Gamma irradiation is highly penetrating and therefore requires adequate protective measures.

1.11 Filtration: Typically, membrane filters (0.1 – 0.3 μ) can be used to sterilise heat-labile liquids by acting as a 'sieve' to retain micro-organisms. HEPA filters in microbiological safety cabinet and laboratory exhausts also operate in the same manner with exhaust air.

2 Disinfection

Disinfection is a type of decontamination where a partial reduction of the risk of infection is achieved. **It does not achieve sterility** (ie elimination of all living agents) and therefore is a 'knock down' procedure. Typically, a disinfectant is a liquid but some gases can be utilised as disinfectants.

To be an effective disinfectant, a substance should be non-hazardous to users and the environment, stable, long lasting and quick acting, kill all biological agents, maintain effectiveness upon dilution, non corrosive for equipment and surfaces, non-toxic to user, dissolve in all solvents, unaffected by variations in pH, temperature, organic material, salt, and be cheap to purchase. In reality, no disinfectant achieves this and therefore **a disinfectant must be validated for its effectiveness against the biological agent and under the working conditions.**

The primary mode of action of a disinfectant is by disrupting the metabolism of the biological agent. The efficiency of a disinfectant can be reduced or eliminated by various factors. These include innate microbial resistance (eg lack of uptake, conversion into non-toxic forms, virulence factors, genotypic resistance, protective coats (spores), retaining viability (prions), resistance to desiccation and high or low pH, inactivation by wide variety of substances (eg blood, inorganic chemicals, organic matter), temperature variations, dilution effects, limited contact time, shelf life and storage conditions.

As disinfection is an inherently less reliable method of biological inactivation, they should only be used in situations where other more reliable methods cannot be employed.

Disinfection should not be used when sterilisation is required, other physical methods can be employed, thorough cleaning is adequate and where disposables can be economically used.

Therefore in a laboratory environment, the use of chemical disinfectants should be limited to a few well defined situations.

1. disinfection of instruments and apparatus (when physical methods cannot be used).
2. making certain items safe for subsequent handling.
3. decontamination of hard surfaces e.g. bench surfaces, spillages, some increased risk areas.

When selecting a disinfectant, the toxicity of the chemical to the users and the impact on the environment must be assessed. The risks must be eliminated or if not reasonably practical, controlled (COSHH) and the negative impact on the environment eliminated (Environmental Protection Act).

All users must be trained in the correct make-up and use of disinfectants and must use the appropriate personal protection.

Different disinfectants must not be mixed together or used in combination unless the possibility of hazardous reactions or formation of toxic products has been assessed.

2.1 Microbicidal activity of disinfectants

Least susceptible to disinfectant

Spores, biofilms and cysts: Spores (*B.subtilis*, *C.tetani*, *C.difficile*, *C.botulinum*), Protozoa with Cysts (*Giardia lamblia*, *Cryptosporidium parvum*); biofilms (eg *Pseudomonas* species).

Mycobacteria (*M.tuberculosis*, *M.avium*)

Non-Enveloped (hydrophilic) Viruses (Coxsackie virus, poliovirus, rhinovirus, Norwalk-like Virus, hepatitis A virus)

Fungi (*Candida* species, *Cryptococcus* species, *Aspergillus* species, Dermatophytes)

Vegetative (gram +ve and -ve) Bacteria (*Staphylococcus aureus*, *Salmonella typhi*, *Pseudomonas aeruginosa*, coliforms)

Enveloped (lipid) Viruses (Herpes simplex, varicella-zoster virus, cytomegalovirus, measles virus, mumps virus, rubella virus, influenza virus, influenza virus, respiratory syncytial virus, hepatitis B & C viruses, hantavirus and human immunodeficiency virus)

Most susceptible to disinfectant

2.2 Types of disinfectants, uses, advantages and disadvantages

Disinfectant (active ingredient)	Example	Uses	Advantages	Disadvantages	Suggested working concentrations
Chlorine	Sodium hypochlorite. Chlorine releasing agents (sodium dichloroisocyanurate) eg Actichlor.	Spills, surface disinfectant. Broad spectrum of anti microbial activity (including mycobacteria). Prions inactivated by 20,000 ppm available chlorine.	Low cost, fast acting, readily available	Corrosive to metals, inactivated by organic material, irritant to skin and mucous membranes, shelf life shortens when diluted, reacts with formaldehyde to form carcinogen, leaves residue, chlorine gas liberated.	500 – 10,000 ppm available chlorine (1000 ppm for surface decontamination, 2500 ppm for small spillages, 5000 – 10,000 ppm for large spillages)
Alcohols	70% ethanol, isopropanol.	Surface disinfectant, some external equipment surfaces. Bacteria, fungi and tuberculocidal but varies in effectiveness against viruses	Fast acting, no residue.	Volatile, evaporation diminishes concentration at site, hardens certain material (rubber), deteriorates material, intoxicating.	70% (v/v)
Peracetic acid	Eg Perasafe	Heat sensitive equipment. Broad spectrum of anti microbial activity (including some spores and mycobacteria).	Less corrosive, fast acting at low temperatures, active in presence of organic material	Can be corrosive. Unstable when diluted	Variable (suggested 0.2 – 0.35% (w/v) for mycobacteria)
Peroxygen compounds	Mixtures of hydrogen peroxide, peracetic acid eg Virkon	Spills, surface disinfectant. Activity against bacteria and some viruses. Not effective against spores or mycobacteria.	Less corrosive than chlorine releasing agents. Fast acting.	Corrosive effects, inactivated by organic material, irritant.	1 – 10% (w/v)
Hydrogen peroxide		Surface disinfectant,	Fast acting, breaks down	Corrosive to certain metals.	3 – 6 % (w/v)

		vapour phase fumigation, heat sensitive equipment with higher concentrations.	into non-toxic products	Does not penetrate material effectively. Irritant and causes burns.	
Aldehydes	Formaldehyde, glutaraldehyde, ortho-phthalaldehyde	Broad antimicrobial action but may not be effective against some spores (may need longer contact time). Useful for heat sensitive, corrosive sensitive equipment, Formaldehyde used for vapour fumigation.	Non-corrosive.	Formaldehyde: Toxic and evidence of carcinogenicity. Pungent odour. Strong irritant. Glutaraldehyde: strong sensitiser and irritant. High cost, shelf life shortens when diluted.	Formaldehyde 1 – 8 % (w/v) Glutaraldehyde 0.5 – 2 % (w/v) O-phthalaldehyde 0.5 % (w/v)
Quaternary ammonium compounds	Composition: surface active mixtures and detergents with other disinfectants. eg Trionic, Trigene.	Surface disinfectant, small spills. Less active against gram negative bacteria, vary in anti-viral performance, inactive against spores. Some new formulations purport to be active against mycobacteria.	Non-irritant, non-toxic, non-corrosive	Narrow spectrum microbicidal activity but new formulations with claimed wider activity are being released onto the market.	Variable – consult manufacturer's data.
Iodophors	Iodine with a solubilising agent / carrier	Surface disinfectant where skin contact is not required, some equipment.	Rapid action, sustained release of active component.	Corrosive to metal, may burn tissues / skin, some inactivation by organic material, staining of fabrics.	30 – 50 mg /L for low level disinfection, up to 10,000 mg / L for high level disinfection.
Sodium hydroxide		Prions inactivated by 1% NaOH. Metal surfaces or equipment contaminated by prions	Less corrosive than hypochlorite	Caustic, corrosive.	1% (w/v)

2.3 Biocidal Products Directive: implications for the use of phenol and xylenol based disinfectants

From 1st September 2006, certain disinfectants that contain active substances which are not supported as part of the Biocidal Products Directive review

programme, cannot be placed on the EU market or subsequently stored for any purpose (except for export and disposal).

The clear phenolic-based Hycolin disinfectant, commonly used for inactivation of *Mycobacterium tuberculosis* and contaminated materials, contain active substances (including 2,4,6-trichlorophenol and xylenol), which have not been supported as part of the biocides review and as such this formulation of Hycolin is no longer available from suppliers and manufacturers or for use. Other disinfectants (e.g. Stericol and Clearsol) have been similarly affected.

In the light of this requirement, alternative method(s) of inactivation which are equally effective must be sought and implemented.

Continued use of these products for disinfection purposes is in breach of the BPR 2001 legislation. All unused stocks of unauthorised disinfectants must be disposed, without causing harm to the environment. Please contact the safety department for information on safe disposal.

It should be noted that a UK Research institute was recently (in 2007) served with a Prohibition Notice by the enforcing authority (HSE) for continued use of unauthorised disinfectants.

For further information see the following websites:

<http://www.hse.gov.uk/biosafety/notices/biosn012007.htm>

<http://www.hse.gov.uk/biocides/index.htm>

Guidance / Procedure Note B13

Fumigation

Fumigation is defined in the Control of Substances Hazardous to Health (COSHH)¹ regulations as 'an operation in which a substance is released into the atmosphere so as to form a gas to control or kill pests or other undesirable organisms'.

Laboratory fumigations are typically undertaken to kill infectious micro organisms and / or material following spills or before change of room / safety cabinet filters and other maintenance work is undertaken. Laboratory fumigations are generally carried out using formaldehyde vapour although recently hydrogen peroxide vapour systems have been used in the UK (typically in 'clean rooms'). Any alternative to formaldehyde fumigation must be validated to achieve a sufficient kill of the micro-organism / biological agent.

Legislation

As the fumigation uses and produces substances that are hazardous to health, it is a duty of the employer under COSHH to assess the risks to staff and others, prevent or control exposure, implement control measures, provide training and health surveillance where required.

The Health and Safety Executive (HSE) has produced guidance² for employers, fumigation technicians and safety representatives.

The Approved Code of Practice supporting COSHH requires that for Containment Level 3 and 4 facilities, the workplace is to be sealed to permit disinfection^{1,3,4}. The fumigant must therefore be contained at the required concentration and time to allow effective disinfection and not allowed to escape until extracted safely. No-one must be exposed to levels of fumigant above the Workplace Exposure Limit (WEL) specified in the latest edition of HSE's Workplace Exposure Limits⁵ or in the absence of a WEL value, to the safe appropriate level.

Some chemicals used as fumigant generating substances may be controlled by the REACH (Registration, Evaluation & Authorisation of Chemicals) Regulations 2007⁶. At the time of writing, the evaluation of a number of chemicals (including formaldehyde) that pose 'high concern' to human health and/or the environment is currently underway under the auspices of the Health and Safety Executive. In order for suppliers to be able to assess the risks, information regarding procedures and use may be sought from end users.

The sale of some fumigant generating products may also be controlled under the Biocidal Products Regulations 2001⁷.

Formaldehyde Use in Fumigation

Formaldehyde acts as an alkylating agent, inactivating microorganisms by reacting with carboxyl, amino, hydroxyl and sulphhydryl groups of proteins as well as amino groups of nucleic acid bases. For formaldehyde to act as a disinfectant it must dissolve at adequate concentration, in a film of moisture in the immediate vicinity of the organisms which are to be killed.

Effective fumigation is typically achieved by heat-initiated vapourisation of a 40% solution of formaldehyde (formalin) in water. The water is necessary to maintain a humidity of about 70%, at which the vapour has its maximum antimicrobial effect. Fumigation is usually performed at 70 - 80°C to avoid the production of various unwanted solid polymers, such as paraformaldehyde.

Contact of formaldehyde with hydrochloric acid and other chlorinated disinfectants (eg sodium hypochlorite) forms bis(chloromethyl) ether, which is carcinogenic. Since these chemicals and disinfectants are widely used in laboratories they **must** be removed before any planned fumigation operation.

The current WEL value for formaldehyde is 2 ppm or 2.5 mg.m³ for both short and long term periods and carries the risk phrases R 23/24/25 (**toxic** by inhalation, skin contact and ingestion) and 34, 40, 43 (causes burns, limited evidence of carcinogenic effects and sensitisation by skin contact)⁵. The HSC/E (Health and Safety Commission / Executive) plans to review the limit values for this substance.

Agents causing transmissible spongiform encephalopathy (TSE) are resistant to inactivation by formalin and so its use is not appropriate for these agents.

Health Effects on Exposure to Formaldehyde

The first signs or symptoms noticed on exposure to formaldehyde at concentrations ranging from 0.1 to 5.0 ppm are burning of the eyes, tearing (lacrimation) and general irritation of the upper respiratory passages. Higher exposures (10 – 20 ppm) may produce coughing, tightening in the chest, a sense of pressure in the head and palpitation of the heart. Exposure at 50 – 100 ppm and above can cause serious injury such as collection of fluid on the lungs (pulmonary oedema), inflammation of the lungs (pneumonitis), convulsions or death. Dermatitis due to formaldehyde solutions or formaldehyde containing resins is also a well-recognised problem.

In 2004, the International Agency for Research on Cancer (IARC) reappraised its position on the carcinogenic potential of formaldehyde, taking new studies into consideration, and reached the following conclusion in relation to nasopharyngeal cancer:

“Overall, the Working Group concluded that the results of the study of industrial workers in the USA, supported by the largely positive findings from other studies, provided **sufficient** epidemiological evidence that formaldehyde causes nasopharyngeal cancer in humans.”

Given the importance of formaldehyde as a chemical and the significance and consequences of pronouncing a substance as a “human carcinogen”, the advice of HSC’s Advisory committee on toxic substances, WATCH sub-committee (Working Group on Action to Control Chemicals) was sought on this matter in January 2005. After careful consideration of the available evidence Working Group on Action to Control Chemicals published the following:

- 1) Formaldehyde has probably caused nasopharyngeal cancer in humans;
- 2) In relation to the apparent association seen in some studies between formaldehyde exposure and leukaemia, based on recent reviews of evidence, and also considering biological plausibility, there is no basis for any significant concern for this cancer;
- 3) It is probable that formaldehyde exposure has caused nasopharyngeal cancer in humans, via a mechanism to which it can be predicted that both chronic inflammation (provoked by irritancy) and genotoxicity contributed.

Based on these conclusions further advice and guidance will be produced and distributed by the HSE, however, during the meantime, it makes sense for formaldehyde to be handled in the workplace as a potential occupational carcinogen.

Safe levels of exposure to carcinogens have not been demonstrated, but the development of cancer will be reduced by decreasing exposure. As far as fumigation operations are concerned therefore, engineering controls and stringent work practices should be employed to reduce potential exposure to the lowest feasible limit.

All laboratories should have an up-to-date protocol for dealing with microbiological accidents and emergencies, and this should include precise information about the use and hazards of formaldehyde. All laboratory staff should be made aware that formaldehyde presents a serious hazard to health.

STANDARD OPERATING PROCEDURE FOR FUMIGATION OF CONTAINMENT LEVEL 3 ROOMS

1 When to use room fumigation

Fumigation is required to disinfect the room and equipment and must be performed at the following times:

- Before beginning a major change in the work program
- After a major spillage of infectious material (emergency). It must be noted that some fumigants (eg formaldehyde vapour) will not penetrate organic material readily. Therefore, without compromising safety, large spills may need to be treated with a compatible disinfectant before fumigation. Pre-cleaning (without jeopardising safety) can also increase the efficiency of fumigation.
- Before certain maintenance / servicing operations (eg replacing filters, servicing of safety cabinets)

2 Responsibility

It is the responsibility of the persons implementing the procedure to ensure that they are competent to undertake the procedure (instructed and trained), to ensure that the instructions in the SOP are followed and that procedures are carried out in accordance with the relevant safety regulations^{1,3}.

3 Safety

A detailed risk assessment must be performed **in advance** of the operation. This should include the choice of fumigant, storage and transport of fumigant, equipment used in the operation, detection equipment, required personal protective equipment (respiratory protective equipment, laboratory coat, gloves, goggles), defining the fumigation risk area, warning signage, validation controls, timing of fumigation, isolation and sealing of area, removing sources of ignition, required amounts of fumigant, training of competent fumigators (fumigation technicians).

ONLY ONE ROOM OR AREA SHOULD BE FUMIGATED AT A TIME.

The following procedure for fumigation is detailed using formaldehyde as the fumigant. If a different fumigant is to be used (eg vapour hydrogen peroxide), it must be validated to effectively decontaminate the biological agent (eg achieve a 6-log kill). See Guidance Note B12 for further information on the types, advantages and disadvantages of different fumigants. Please consult a Health & Safety Adviser before attempting room fumigations with a fumigant other than formaldehyde.

4 Equipment

- 4.1 Laycock fumigator (prepared fumigator kit containing paraformaldehyde and potassium permanganate) and a small jug of cold water; the number of fumigators required must be determined during the planning stage. A concentration of 0.05g of formaldehyde per m³ is required to achieve effective fumigation. **Excessive quantities should not be used.**
- 4.2 **Alternatively**, a mixture of formalin and water can be heated in a thermostatically controlled heating unit (eg electric kettle with unexposed heating element) or specialised vapourising unit. Use 100 ml formalin plus 900 ml water per 28.3 m³ (1000 ft³) of space. **Excessive quantities should not be used.**

WARNING: mixing formalin and water with potassium permanganate crystals. The correct relative concentration of these two components is essential to avoid a violent reaction. It is therefore recommended that this method is NOT used.

- 4.3 Fan
- 4.4 Temperature/humidity monitor
- 4.5 Gastec gas sampling pump and canisters and / or formaldemeter (for monitoring) that can accurately measure levels of fumigant below the WEL.
- 4.6 Lab coat, gloves, goggles and respirator for each operator
- 4.7 Metal ducting tape
- 4.8 Validation controls especially for an initial operation (eg spore strips / discs of *Bacillus subtilis* var. *Globigii* or *Geobacillus stearothermophilus*). A positive control for the operation should be included.

5 Procedure

- 5.1 Inform the following by phone and/or e-mail that you want to perform the procedure **at least 1 week in advance** (unless there is an emergency spillage) that you plan to fumigate the room on a given date and at a given time:

Appropriate Campus Maintenance Manager
Appropriate School / Institute Safety Coordinator / Building Manager
QMUL Health & Safety Office

A checklist or record sheet should be used to record details and progress of operation.

A Permit to Work form (available from the QMUL H & S website) must be completed before fumigation is carried out.

- 5.2 The day before fumigation switch off any air conditioning, ovens and any other equipment and allow the room to reach ambient room temperature. The room temperature must be above 18°C to enable sufficient formaldehyde vapourisation.
- 5.3 Remove any chlorinated disinfectants / liquids or ensure containers are tightly closed. If possible (without compromising safety), pre-cleaning may be conducted to increase efficacy.
- 5.4 On the day of fumigation, remove any absorbent material and liquids that are not required to be fumigated.
- 5.5 Attach warning signs at the fumigation area and all points of access to the risk area. The signage must identify the use of a toxic gas and warnings stating 'do not enter' and 'fumigation in progress'.

An example (in accordance with the Health and Safety (Safety Signs and Signals) Regulations 1996, is shown below.



- 5.6 Lock the laboratory so that no accidental access is possible.
- 5.7 Place the temperature/humidity monitor in a position it can be seen from outside the room.

6 Preparation and sealing of the room

- 6.1 Estate Maintenance staff will isolate any fume cupboards or air handling systems connected to the room supply/extract system and will place a "DO NOT SWITCH ON" sign on the controls.
- 6.2 The room must be sealed for fumigation with suitable metallic ducting tape.
- 6.3 If it is not safe for staff to enter the room before fumigation (eg due to a spill of infectious material), alternative means must be in place to seal the room at external points and / or establish a cordoned area and evacuate all persons.
- 6.4 All socket outlets, lights, fire detectors will be sealed with metal ducting tape. Water will be run into u-bends in sinks.
- 6.5 Estate staff will assist to seal off any air supply and extract diffuser grills using blanking plates which will be sealed with tape.
- 6.6 All equipment; incubators, safety cabinets etc. must be opened.
- 6.7 The door seal and the transfer grille should be prepared in advance.

7 Face fitted Respirators

- 7.1 Initial selection process for all tight-fitting face pieces must include an individual and product specific, face-fit testing using a recognised quantitative test method conducted by a competent person⁸. The wearer must be aware of the level of protection offered by the respirator and the equipment must undergo regular inspections. Further guidance is given in the HSE publication HSG53 *Respiratory protective equipment at work*.⁹ (<http://www.hse.gov.uk/pUbns/priced/hsg53.pdf>)

7.2 Visual checks before use

Check the head-band for elasticity, breaks or tears and the correct functioning of the head-band attachments
Check the face piece and inner-masks for cracks, distortion, tears and flexibility
Check the valves for cracks, tears distortion or dirt between the valve and seal
Check the cover of the exhalation valve is in place
Check all plastic parts of the respirator for cracks and material fatigue

Filters

Fit new formaldehyde filter cartridges to the respirators.

Fit test the respirators

Place hands firmly over the inlet to the filter and breathe in. A negative pressure should be felt inside the mask.

If any leakage is detected, re-adjust the respirator and repeat the test until a satisfactory face-fit is achieved.

8 Setting up the Laycock fumigator

- 8.1 Once the room is prepared, two trained fumigators with required PPE will prepare the formaldehyde fumigator as follows:
- Empty the powder in the small jar into the contents of the large jar and mix well.
 - Have a jug with cold water ready to fill the small jar to the inner neck, not to the rim. Put to one side.
 - Place the large container on a heat resistant surface.
 - Add the water from the jug into the contents of the large jar.
 - Switch on the fan. Ensure that it is faced away from the door on a low speed.

LEAVE THE ROOM IMMEDIATELY AND SEAL THE DOOR

If more than one fumigator is used, first activate the one furthest from the door.

8.2 **Using a formalin water heating or vapourising device**

Pour appropriate quantities of formalin and water mixture into the heater unit.

When ready, activate the heater.

LEAVE THE ROOM IMMEDIATELY AND SEAL THE DOOR.

8.3 **The exothermic reaction takes between 1 – 5 minutes depending on the room temperature.**

Evacuate the room for at least 6 hours.

9 **Ventilation of the room**

- 9.1 After at least 6 hours, go to the external switch control and turn to fumigation extract mode. Any safety cabinets should also be set to extract via the external control switch.
- 9.2 If there is possibility of any intake into other windows/ vents these should be identified and sealed to prevent ingress of formaldehyde.
- 9.3 After about 1-2 minutes, remove the metal ducting tape from the bottom of the door and then remove the seal from any door grille.
- 9.4 Leave overnight.

10 **Monitoring formaldehyde concentration**

- 10.1 See the SOP / manufacturer's instructions for the Gastec monitor and/or formaldemeter.

- 10.2 The following formula can be used to calculate the time required to purge the room:

$$\text{Time (mins) X25} = \frac{\text{room volume (m}^3\text{)}}{\text{room extraction rate (m}^3\text{.min}^{-1}\text{)}}$$

- 10.3 Monitoring must take place **external** to the room (eg porthole or outside door) and measurements must be made until a reading of less than 1ppm formaldehyde is observed. If readings are higher, turn on fans again for a further 2 hours.

- 10.4 If levels are within the acceptable range, remove all the tape from the door and switch off the fans.
 - 10.5 Remove all signs from the door and fume cupboards.
 - 10.6 All metal ducting tape will now require removal from the extract covers, sockets etc. Protective clothing must be worn during this process (laboratory coat, overshoes and suitable gloves).
 - 10.7 All surfaces with formaldehyde residues must be cleaned and disposed via chemical waste route.
 - 10.8 Assess validation controls (eg culturing of spore strips).
- 11 Complete fumigation record and assess any problems encountered to improve subsequent operations.**

References

- 1 The Control of Substances Hazardous to Health (Fifth edition): The Control of Substances Hazardous to Health Regulations 2002 (as amended) Approved Code of Practice and guidance. HSE Books, ISBN 07176 29813, 2005.
- 2 Fumigation: Health and safety guidance for employers and technicians carrying out fumigation operations. HSE Books, ISBN 07176 29999, 2005.
- 3 The management, design and operation of microbiological containment laboratories: Advisory Committee on Dangerous Pathogens (ACDP). HSE Books, ISBN 07176 20344, 2001.
- 4 Sealability of microbiological containment level 3 and 4 facilities.
<http://www.hse.gov.uk/biosafety/gmo/guidance/sealability.pdf>
- 5 Workplace Exposure Limits: Containing the list of workplace exposure limits for use with the Control of Substances Hazardous to Health Regulations 2002 (as amended). HSE Books ISBN 0717629775, 2005.
<http://www.hse.gov.uk/coshh/table1.pdf>
- 6 <http://www.hse.gov.uk/reach/>
- 7 <http://www.hse.gov.uk/biocides/index.htm>
- 8 Personal Protective Equipment at Work (Second edition): Personal Protective Equipment at Work Regulations 1992 (as amended). HSE Books ISBN 07176 61393, 2005.
- 9 Respiratory protective equipment at work: A practical guide. HSG53 (Third edition). HSE Books 2005 ISBN 07176 2904X.

Guidance / Procedure Note B14

Safe and effective use of autoclaves

Introduction

Autoclaves are used as a means of sterilizing a wide range of materials, particularly those associated with biological laboratories.

Principles of sterilization

Sterilization is an absolute term – it is the complete killing of all living organisms. Autoclaves utilise saturated steam under pressure and its associated latent heat, which under the controlled conditions will kill all forms of life* including the most heat-resistant bacterial spores. Four main factors therefore affect the efficiency of sterilization by steam: air removal, penetration of steam, presence of moisture and heat penetration. As air is a good insulator, air removal from the load is required for steam to penetrate and heat efficiently. Moist heat is required as proteins in living organisms are protected from denaturation by dry conditions.

Use of autoclaves in laboratories

Autoclaves may be used for the sterilization of liquid and solid media, micropipette tips, filters, empty containers and a wide range of instruments (Figure 1). In this case the aim is to inactivate any contaminating organisms occurring on the surfaces or within the material, rendering it sterile.



Figure 1: Bench top autoclaves used for media preparation and sterilization of instruments and pipette tips.

Autoclaves are also used for the inactivation of waste laboratory materials which are known to be (or potentially could be) contaminated with pathogenic organisms, genetically modified organisms, and pathological samples such as blood which may contain pathogens (Figure 2).



Figure 2: Autoclaves used for the inactivation of infectious and genetically modified agents.

Operation of autoclaves

There are many makes and types of autoclaves and most of the modern machines are capable of operating over a range of different cycles which can be varied to provide optimal processing of specific materials.

During a basic cycle, provided by a conventional bench top autoclave, water is heated by an element in the base of the machine to produce steam. The steam is allowed to vent until any air in the autoclave chamber has been exhausted. The exhaust valve closes, allowing steam to reach a predetermined pressure. This is then held for a set time (holding time) to allow sterilization to take place. The heaters are then switched off and the steam condenses to water until the chamber has returned to ambient pressure.

More sophisticated autoclaves have a pre/post-vacuum cycle which enables air to be removed from the chamber prior to the introduction of steam. This increases the efficiency of the process, by removing pockets of air from both the chamber and the material to be sterilized.

This enables a more rapid and efficient sterilization process to take place. The post-vacuum part of the cycle reduces the cooling time and has the added effect of helping to dry the contents. This is useful if the material is an absorbent material, which has to be dried before use or further processing, such as laboratory gowns. An autoclave process including vacuum steps should not normally be used to sterilize bottles or flasks containing liquids owing to the risk of explosion/implosion and loss of material which may be drawn out of the containers under vacuum.

Where highly infectious waste is produced, such as in Containment Level 3 and 4 laboratories, it is usual to install autoclaves within the wall of the laboratory in order that material can be placed into the chamber within the laboratory and only removed from the 'clean' end, within an adjoining lobby when the autoclave has successfully completed the sterilization cycle (Figure 3).



Figure 3: Double-ended autoclaves are fitted in Containment Level 3 and 4 laboratories

Training

In order to ensure that an autoclave is used effectively and safely a series of guidelines must be strictly adhered to, i.e. a standard operating procedure. Untrained personnel must **never** be permitted to use an autoclave. Training on the safe use of autoclaves must be provided for all users¹.

Safety Procedures and operation

Autoclaves under operating conditions contain steam under pressure and are therefore potentially dangerous. In order to protect the operator autoclaves are fitted with a thermal safety lock which prevents the door being opened at the end of a sterilizing cycle until the internal pressure has returned to ambient and the temperature has decreased to an acceptable level, usually around 60°C.

Sealed containers must not be autoclaved; bottles and containers must have their caps loosened. If infectious material is within the bottles or containers, filtered vents can be used to ensure containment until sterilization.

Waste material that is to be processed must be transferred to a secondary container before placing it into the autoclave. These containers are usually stainless steel or polypropylene boxes and these will keep the material contained and prevent any of the contents leaking into the autoclave itself. Solid waste material, such as flasks and Petri dishes should be placed into autoclave bags and then into secondary containers. Sharps and glassware should be segregated from plastic and other disposable consumables. Care should be taken to ensure that air is not trapped within waste material (make sure any tubing is not kinked, lab coats, gowns and other clothing is packed loosely and not rolled up, pack paper, gloves loosely)

The necks of the bags must be left open to allow free penetration of steam. Autoclave bags are produced in various materials depending on the temperature that they are to be used at. The high temperature bags, suitable for sterilization at 134°C are made of polypropylene.

Protective equipment²

When removing items from an autoclave a laboratory coat, full-face visor and heat-resistant gloves must be worn. Although careful training in the use of autoclaves, coupled with the integral fail-safe mechanisms such as thermal locks will dramatically reduce the risk to the

operator, there is still a potential for bottles and other vessels to explode or implode. Care should be taken when opening the autoclave door at the end of a cycle as occasionally some residual hot water may spill from the machine.

Chemicals and explosive substances

Items containing volatile chemicals (e.g. phenol, trichloroacetic acid, chloroform etc), solvents and certain disinfectants must not be autoclaved as the process would enable toxic chemicals to escape into the atmosphere putting users at risk. Radioactive material must not be autoclaved as the sterilization process will spread contamination. Explosive substances such as batteries, nitrocellulose, aerosols and flammables must not be autoclaved. Pathogenic material in association with these substances must be made safe by another decontamination process (eg chemical disinfection). Some disinfectants can also cause corrosion of autoclave equipment over time (eg sodium hypochlorite).

Validation and Calibration

Most autoclaves used for the sterilization of media and non-infectious materials are often calibrated for a cycle with a holding time of 15-20 minutes at 121°C. This temperature is achieved at a steam pressure of 15 psi. For the preparation of media and the sterilization of material for research purposes, complete sterilization of material is not always essential. For instance the preparation of agar plates for bacteriological purposes are often discarded after a day or two, long before a few contaminating bacteria are able to cause any problems.

However, autoclaves that are used for the processing of infectious or potentially infectious waste **must** be validated in order to ensure that all infectious material is completely inactivated, by confirmation of the time that the required temperature has been reached within the waste material. It is a legal requirement^{3,4,5} to ensure that both infectious and genetically modified material is completely inactivated prior to being removed from the premises for incineration. Autoclaves that use steam sterilization are tested and validated according to British Standard 2646⁶. As micro-organisms are killed according to logarithmic kinetics, a zero point is not measurable. Validation of a make safe process is therefore achieved by establishing a finishing point of a 12-log reduction. This establishes a sufficient safety margin to ensure complete kill.

Autoclaves used for the inactivation of waste materials may also be operated at 121°C, especially where liquids are concerned, but this temperature would either be monitored with a probe inserted into the load, or the cycle would have been based on the temperature and times required to reach sterilizing temperatures within dummy loads. These autoclaves are frequently set to run at higher temperatures for shorter periods, such as 134°C for 5 minutes

Validation of the sterilization process may be performed in one of two main ways. A 'load sense' probe may be inserted into each batch of material. The probe would monitor the temperature within the load and ensure that the sterilizing temperature is reached and held for sufficient time for complete inactivation.

Alternatively, a 'dummy load' system may be used. This is useful if the waste to be sterilized always tends to be very similar. Prior to use the autoclave is set up to run with load probes (thermocouples) placed within representative areas of the dummy load. This consists of a container or autoclave bag with contents that are representative of typical waste loads – but not including infectious material. A printout showing the temperatures recorded by the thermocouples within different areas of the load is produced.

It is often found that even after a cycle operating at high temperatures and for relatively long holding times that certain parts of the load have not reached an appropriate temperature for long enough to enable sterilization to be complete. Therefore the process has to be started afresh with a new dummy load using an amended program.

Methods of controlling the sterilization process

In order to ensure that sterilization has been achieved, one can rely on the fact that a correctly calibrated autoclave, used according to the Standard Operating Procedure (SOP) will provide this. This can be confirmed by a printout of the process showing the temperature achieved throughout the cycle. The majority of modern autoclaves will prevent the chamber door from being opened at the end of a cycle if it has not been completed satisfactorily. However, it is recommended that the process, certainly when infectious/GM material is involved for an independent means of monitoring the process to be used. This may be performed using either chemical or biological indicators.

Autoclave tape is commonly attached to material that is to be autoclaved. This is a heat-sensitive tape that indicates its exposure to heat by the formation of a series of brown diagonal lines. However, although this may be regarded as a chemical indicator, autoclave tape does not provide any indication that the material to which it is attached has actually been heated to a sufficient temperature for an adequate time in order to provide complete sterilization – merely that it has been heated.

However, a steam chemical integrator such Thermalog Comply strips (3M Healthcare # 2134MM) which clearly indicate, by means of a moving colour band, whether or not sterilization criteria have been met, is a reliable means of monitoring the process independently. Alternatively, strips of absorbent paper containing spores (*Geobacillus stearothermophilus*) may be added to the load. The strips must then be incubated in a liquid medium in order to confirm that the spores have been destroyed.

Insurance inspections

Under the required legislation^{7,8} as steam pressure vessels, autoclaves are subject to regular safety checks which are routinely carried out by inspectors who are specialists working for insurance companies. These inspections must be performed at least every 14 months, although an annual arrangement is often more convenient. Queen Mary currently uses the services of Zurich Municipal Insurance for this purpose. The autoclaves are examined to determine whether there are any faults within the pressure chamber, such as corrosion or defective welding, which would render the vessel dangerous. All autoclaves contain a safety valve which will vent steam from the sterilization chamber should the pressure exceed a set limit. Regular testing of this valve forms an important part of the insurance inspection. As part of the inspection requires access to some internal components of the autoclave, this procedure is best coordinated with a routine preventative maintenance visit, during which the engineer will open up the machine for the insurance inspector.

SUMMARY

Steam sterilization is the best method to render a substance or object free of living organisms.

Steam and heat need to be in close contact to substance or object to sterilize.

Steam sterilization by autoclaves can be used to sterilize laboratory media and consumables and inactivate waste material.

Depending on the required use, different types of autoclaves are used in laboratories – from compact bench top to double ended.

Users must be trained to use an autoclave safely according to a standard operating procedure.

Autoclaves must be calibrated and validated for the process undertaken and be insured as pressure vessels.

Autoclaves must have thermal safety locks to prevent injury to users and others.

Personal protective equipment must be worn when using autoclaves.

Autoclave processes must have indicators / process printout to verify sterilization of infectious / genetically modified waste.

Certain substances that could spread contamination and cause explosion must not be autoclaved.

Waste material must be packed to ensure maximum steam penetration – loosen container caps, pack consumables loosely, ensure air traps are not present in material.

Failed autoclave runs containing infectious material must be successfully re-run before autoclave chamber is opened.

Note

*Prion protein containing material causing Transmissible Spongiform Encephalopathies (TSE's) is not inactivated by steam sterilization. See guidance by ACDP at <http://www.advisorybodies.doh.gov.uk/acdp/tseguidance/index.htm> and Guidance Note 17.

References

- 1 Safe use of work equipment: Provision and Use of Work Equipment Regulations 1998. HSE Books ISBN 07176 16266, 1998.
- 2 Personal Protective Equipment at Work (Second edition): Personal Protective Equipment at Work Regulations 1992 (as amended). HSE Books ISBN 07176 61393, 2005.
- 3 The Control of Substances Hazardous to Health (Fifth edition): The Control of Substances Hazardous to Health Regulations 2002 (as amended). Approved Code of Practice and guidance. HSE Books, ISBN 07176 29813, 2005.
- 4 The Genetically Modified Organisms (Contained Use) 2000: A guide to the Genetically Modified Organisms (Contained Use) Regulations 2000. HSE Books, ISBN 07176 17580, 2000.
- 5 The management, design and operation of microbiological containment laboratories: Advisory Committee on Dangerous Pathogens (ACDP). HSE Books, ISBN 07176 20344, 2001.
- 6 BS2646-1 to 5:1993 Autoclaves for sterilization in laboratories.
- 7 Safety of pressure systems: Pressure Systems Safety Regulations 2000: Approved Code of Practice. HSE Books ISBN 071761767X, 2000.
- 8 The Pressure Equipment Regulations 1999. The Stationary Office ISBN 9 780 1108 2790 2, 1999.

Further Guidance documents

Sterilization, disinfection and cleaning of medical equipment: guidance on decontamination from the Microbiology Advisory Committee to the Department of Health, Medical Devices Agency (MAC manual), 2002 and subsequent additions.

http://www.mhra.gov.uk/home/idcplg?ldcService=SS_GET_PAGE&ssDocName=CON007438&ssSourceNodId=265&ssTargetNodId=575

Benchtop Steam Sterilizers – Guidance on purchase, operation and maintenance. Medical Devices Agency, 2002.

http://www.mhra.gov.uk/home/idcplg?ldcService=SS_GET_PAGE&useSecondary=true&ssDocName=CON007326&ssTargetNodId=572

Transport and receipt of Biological Material

1 Introduction

Certain biological samples, cultures and other materials fall within the description of 'Carriage of Dangerous Goods' (CDG) and both national and international legislation demand that stringent requirements must be met if the goods are transported (consigned) by any means. All QMUL staff and students must ensure Regulations applicable to the transport of biological materials are complied with for each particular consignment and not carry, consign, package or play any other role in the transport chain if they are not competent to do so.

Even if the particular biological material to be transported is not hazardous and does not fall under the description of dangerous goods, the item must still be packed safely for carriage.

Any problems occurring during transport, such as leakage or breakage, should be reviewed in order that corrective measures can be taken to prevent any recurrence. If workers in the University receive packages that are not properly packaged or labeled, they should contact the originator to advise of the problem and advise that any future packages meet the legislative standards.

Under the COSHH Regulations, consignment (transport) of materials containing or suspected of containing Hazard Group 4 biological agents must be notified in advance to the enforcing authorities. QMUL does not hold a license to work with HG 4 agents and does not contain facilities suitable for handling such agents. Individuals, Departments, Schools or Institutes must not, under any circumstances, either consign or receive these materials. Any breach of this prohibition **must** be notified to the Head of Department / School / Institute and the QMUL Biological Safety Adviser immediately.

This guidance document details procedures for the transport and receipt of biological material to/from **sources external** to the College.

Procedures for the transport and receipt of biological material **exclusively within** QMUL are noted in the 'Procedure for the Transport and Receipt of Hazardous Materials' document (QM/H&S/0017).

2 Legislation

The international requirements for the transport of dangerous goods by road, rail, air and sea are based on the recommendations (termed 'Modal Regulations') made by the Committee of Experts on the Transport of Dangerous Goods, which is a committee of the UN Economic and Social

Council. The legally binding UN modal regulations are then adopted by the international body responsible for the mode of transport and a publication is issued containing the regulations. European Directives and UK legislation adopting the UN modal regulations are passed with suitable variations.

The following International, European and UK legislation governs transport of Dangerous Goods:

- i **Road and Rail:** The UK Carriage of Dangerous Goods and Use of Transportable Pressure Equipment Regulations 2007 (CDG 2007) adopts the European Directive for the 'Accord européen relatif au transport international des marchandises dangereuses par route' (known as 'ADR'), and the Regulations concerning the International Carriage of Dangerous Goods by Rail (RID). The ADR regulations also apply to vehicles carrying dangerous goods on ferry crossings.
- ii **Air:** The International Civil Aviation Organisation (ICAO) issues technical instructions (Safe Transport of Dangerous Goods by Air) which are adopted by the International Air Transport Association (IATA). In the UK, the Civil Aviation Authority (CAA) provides interpretation on instructions.
- iii **Sea:** The International Maritime Dangerous Goods Code is published by the International Maritime Organisation (IMO) and is applied in the UK by the Maritime and Coastguard Agency (MCA).
- iv **Post:** the Letter Post Manual published by the Universal Postal Union (UPU) reflects the UN modal regulations. Royal Mail and other couriers adopt this manual with suitable variations.

3 Definitions

Biological agents and material that are deemed 'Dangerous Goods' by the transport regulations are termed '**infectious substances**'.

Infectious substances: *For transport purposes*, infectious substances are substances which are known or are reasonably expected to contain pathogens. Pathogens are defined as micro-organisms (including bacteria, viruses, rickettsia, parasites, fungi) and other agents such as prions which can cause disease in humans or animals.

Cultures, patient specimens, isolates, genetically modified organisms, biological products, medical and animal waste may fall under the classification of 'infectious substances'.

The regulations assign infectious substances into two categories, **Category A** and **Category B**. The categorisation of the infectious substance depends on the ability of the substance to cause severe or fatal disease in humans or animals if they are exposed to it. (The Carriage of Dangerous Goods Regulations no longer directly follow the WHO / ACDP Hazard Group classification of pathogens to decide categorisation of infectious substances).

Category A: an infectious substance which is carried in a form that, when exposure to it occurs, is capable of causing permanent disability, life-threatening or fatal disease in otherwise healthy humans or animals.

An **indicative list** of infectious substances that meet these criteria is provided in the regulations and reproduced here in Table 1. However, the table should not be regarded as exhaustive. Other infectious substances, including new or emerging pathogens, which do not appear in the table but which meet the same criteria must be assigned to Category A and if there is doubt as to whether or not a substance meets the criteria it should be included in Category A.

Category B: an infectious substance which does not meet the criteria for inclusion in Category A.

Exempt (biological) substances:

Because of the low hazard the following substances *may be* exempt from Carriage of Dangerous Goods Regulations (from 2006):

- i Substances which do not contain infectious substances or will not cause disease in humans or animals
- ii Substances containing micro-organisms which are non-pathogenic to humans or animals
- iii Substances in a form that any present pathogens have been neutralised or inactivated such that they no longer pose a risk to health
- iv Environmental samples (including food and water samples) for which there is a low probability that infectious substances which are not considered to pose a significant risk of infection
- v Dried blood spots (on absorbent material) or faecal occult blood screening tests
- vi Blood and blood components collected for the purpose of transfusion or blood products and any tissues or organs for use in transplantation.

Professional judgment must be used to determine whether it is appropriate to transport samples as 'Exempt' human or animal specimens. The judgment should be based on known medical history, symptoms and individual circumstances of the source (human or animal), and endemic local conditions. For example, samples from healthy individuals, or where there is no reason to suspect that the person is suffering from a severe infectious disease, and the sample is not being tested for the presence of pathogens, would be exempt.

(e.g. blood or urine tests to monitor cholesterol levels, blood glucose levels, hormone levels or prostate specific antigens; tests required to monitor organ function such as heart, liver or kidney function for humans or animals with non-infectious diseases, or therapeutic drug monitoring; tests conducted for insurance or employment purposes and are intended to determine the presence of drugs or alcohol; pregnancy tests; biopsies to detect cancer; and antibody detection in humans or animals).

4 Classification and identification

Dangerous Goods are assigned 'UN numbers' and 'Proper Shipping Names' according to their hazard classification and composition.

Dangerous Goods that are 'Infectious substances' as detailed in section 3 are assigned to UN Class 6.2

Classification: Class 6.2 (Infectious substances)

Identification: (UN ID number and Proper Shipping Name)

For Category A:

UN 2814 INFECTIOUS SUBSTANCE, AFFECTING HUMANS

UN 2900 INFECTIOUS SUBSTANCE, AFFECTING ANIMALS only

The form of the substance can be affixed to the proper shipping name: (solid) or (liquid).

Cultures, genetically modified micro-organisms and organisms, biological products (eg vaccines), clinical and diagnostic specimens*, medical or clinical wastes that are or contain Category A infectious substances must be assigned to UN 2814 or UN 2900 as appropriate.

*Note: Researchers may undertake studies which involve taking diagnostic or clinical samples from volunteers where there is a relatively high incidence of hepatitis B, HIV or TB within the general population of the area. These pathogens appear on the indicative list for Category A infectious substances but the entries refers to cultures only. Such samples can be assigned to Category B providing the pathogens have not been intentionally propagated (see Table 1 for further details).

Animal carcasses affected by pathogens of Category A or which would be assigned to Category A in cultures only, should be assigned to UN 2814 or UN 2900 as appropriate.

For Category B:

Cultures, genetically modified micro-organisms and organisms, biological products, and diagnostic or clinical specimens (human and animal) should be assigned the following ID and Proper Shipping Name if they meet the conditions for Category B.

UN 3373 BIOLOGICAL SUBSTANCE, CATEGORY B

Animal carcasses affected by pathogens categorised as Category B should be carried in accordance with provisions determined by the competent authority.

Medical or clinical wastes containing infectious substances in Category B should be assigned to the following ID and Proper Shipping Name:

UN 3291 CLINICAL WASTE, UNSPECIFIED, N.O.S., or (BIO) MEDICAL WASTE, N.O.S. or REGULATED MEDICAL WASTE.

Notes on classification:

Unless an infectious substance cannot be consigned by any other means, live animals shall **not** be used to consign the pathogen. If consigned, they must only be carried under terms and conditions approved by the competent authority.

Genetically Modified Micro-organisms and Organisms that do **not** meet the definition of an 'infectious substance', but are capable of altering animals, plants or microbiological substances in a way not normally the result of natural reproduction are classified in Class 9 (Miscellaneous Dangerous Goods) and should be identified as UN 3245 GENETICALLY MODIFIED MICRO-ORGANISMS.

Toxins from plant, animal or bacterial sources which do **not** contain any infectious substances or organisms or which are not contained in them are substances of Class 6.1, UN 3172 or 3462 (see ADR regulations for further details).

Up to 31st Dec 2006, Category B substances were referred to as UN 3373 DIAGNOSTIC SPECIMENS or UN 3373 CLINICAL SPECIMENS. However, after 1st Jan 07, these terms are no longer permitted.

5 Packing requirements

The **triple packaging system** described by the WHO must be used for all infectious substances (Category A and B), exempt substances and non-infectious GM substances.

This consists of three layers as follows:

Primary receptacle: water-tight and leak proof with enough absorbent material to absorb all fluid in the event of a breakage.

Secondary receptacle: a durable, water-tight and leak-proof packaging to enclose and protect the primary receptacle. Several cushioned primary receptacles may be placed in one secondary package but sufficient absorbent material should be used to absorb all fluid in a breakage. Goods of an unrelated type must not be packed together.

Outer packaging: secondary receptacles are placed in a durable outer packaging with suitable cushioning material to protect from outside influences.

The minimum dimensions of the package should be 100 x 100 mm on at least one surface.

Packaging for Category A and B infectious substances must adhere to specific UN Class 6.2 requirements (termed a Packing Instruction).

Category A infectious substances must be packed in accordance with ADR Packing Instruction 620 (for road transport) and IATA Packing Instruction 602 (for air transport). The two are analogous. The UN-approved packaging must meet stringent performance criteria issued by the UN; these include a 9 m drop test, a puncture test and a pressure test (able to withstand a pressure differential of at least 95 kPa). There are limits on the maximum quantity in a package that can be carried by air transport but not for road transport (see section 11 summary chart and section 9). A list of commercial suppliers for approved packaging is given at the end of this document.

Category B infectious substances must be packed in accordance with ADR Packing Instruction 650 (road transport) and IATA Packing Instruction 650 (air transport). UN-type approved packaging is not required, providing it is suitable for its purpose and capable of passing a 1.2 metre drop test. For air transport, there are limits on the maximum quantity in a package (see summary chart in section 11 and section 9).

Both Category A and B infectious substances should contain an itemized list of contents on the outer surface of the secondary packaging. When several primary receptacles are packed together or if refrigerants are used to protect contents, the surrounding 'overpack' must also show all markings and labeling that are inside.

Sections 13 and 14 below give a schematic illustration of the packaging requirements. Listed reference documents below give the complete detail of Packing Instructions.

Exempt and non-infectious substances do not require packaging to a Packing Instruction but should follow the triple packaging system.

6 Marking and Labelling

Category A infectious substances assigned to either UN 2814 or UN 2900

i appropriate UN number and proper shipping name

UN 2814 INFECTIOUS SUBSTANCE, AFFECTING HUMANS or

UN 2900 INFECTIOUS SUBSTANCE, AFFECTING ANIMALS only

(liquid) or (solid) as appropriate

- ii UN specification marking to verify suitability of packaging for Class 6.2 (eg 4G/Class 6.2/05/GB/2470). This will normally be affixed by the manufacturer of the packaging.
- iii hazard warning label for Class 6.2 - Infectious substances



The lower half of the label may, but is not required to, bear the inscriptions 'INFECTIOUS SUBSTANCE' and 'In the case of damage or leakage immediately notify Public Health Authority'.

It is no longer necessary to show the scientific / technical name on the package, but is required in the accompanying transport documentation

- iv Emergency contact details (name and telephone number) must be shown on outer packages containing Category A infectious substances.
- v Orientation labels (UP arrows) on at least two surfaces.
- vi. Consignor and consignee names and addresses.
- vii. If dry ice (UN 1845) is used, hazard label 1 shown below and the statement 'DRY ICE' or 'CARBON DIOXIDE, SOLID' and the net quantity. If liquid nitrogen is used, label 2 and 3 (outer insulated vessels for air transport only) and the net quantity. ICAO / IATA Packing Instruction 904 must be adhered to for dry ice and liquid nitrogen. Label 4 must be attached for 'Cargo Aircraft Only' packages if it is only permitted on cargo aircraft.

Label 1

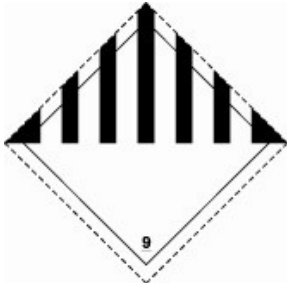

Label 2



Label 3

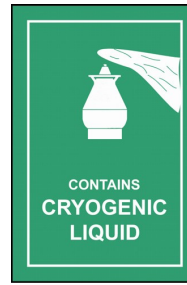

Label 4



Category B infectious substances assigned to UN 3373

- i appropriate UN number and proper shipping name
UN 3373 BIOLOGICAL SUBSTANCE, CATEGORY B
- ii hazard warning label for Class 6.2 - Infectious substances



- iii. Consignor and consignee names and addresses
- iv Emergency contact name, address and telephone number (required for air transport).
- v. if dry ice (UN 1845) is used, hazard label 1 shown below, the net quantity and the statement 'DRY ICE' or 'CARBON DIOXIDE, SOLID'. If liquid nitrogen is used, label 2 and 3 (outer insulated vessels for air transport only) and the net quantity. ICAO / IATA Packing Instruction 904 must be adhered to for dry ice and liquid nitrogen. Label 4 must be attached for 'Cargo Aircraft Only' packages.

Label 1

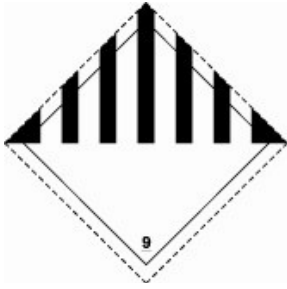

Label 2



Label 3

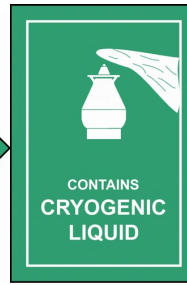

Label 4

Non-infectious Genetically Modified Micro-organisms or Organisms

- i appropriate UN number and proper shipping name

UN 3245 GENETICALLY MODIFIED MICRO-ORGANISMS or ORGANISMS

and Label 1 shown above

- ii Dry ice, liquid nitrogen labelling as appropriate.

Exempt substances

- i EXEMPT HUMAN SPECIMEN or EXEMPT ANIMAL SPECIMEN

- ii Dry ice, liquid nitrogen labelling as appropriate.

7 Documentation

Category A infectious substances assigned to either UN 2814 or UN 2900

The following shipping documents are required (prepared by the shipper or the shipper's agent (eg courier or transport agent). The forms may be obtained from the courier company, transport company, national customs or IATA websites (a fee may be payable).

- i for air transport, the 'Shipper's Declaration for Dangerous Goods' or equivalent for surface transport

- ii an air waybill for air transport *or* equivalent documents for surface transport
- iii a packing list/proforma invoice that includes the receiver's address, the number of packages, detail of contents, weight, value.
(Note: for international transport, a minimal value shall be indicated for customs purposes, if the items are supplied free of charge)
- iv Written emergency response procedures (for a model form see section 12 below).
- v an import and/or export permit and/or declaration (if required).
- vi For UN 2814 and UN 2900, an itemized list of contents shall be enclosed between the secondary packaging and the outer packaging.

Category B infectious substances assigned to UN 3373

- i an air waybill for air transport *or* equivalent documents for surface transport
- ii a packing list/proforma invoice that includes the receiver's address, the number of packages, detail of contents, weight, value.
(Note: for international transport, a minimal value shall be indicated for customs purposes, if the items are supplied free of charge)
- iii an import and/or export permit and/or declaration (if required).

Exempt human or animal substances: On QMUL headed paper with contact details, a statement by a named responsible person saying what the materials are, that there is minimal likelihood that pathogens are present and that they are exempted under the transport regulations.

Non-hazardous biological materials: On QMUL headed paper with contact details, a simple statement by a named responsible person saying what the materials are, that they are non-hazardous and that they are not classified as dangerous goods under the transport regulations.

8 Transporters

i Post / Royal Mail:

Infectious substances in Category A (UN 2814 or 2900) will **not** be accepted for transport by any postal operator including Royal Mail. Other infectious substances, micro-organisms or toxins are also prohibited. Certain non-infectious living organisms (bees, leeches, worms, insects etc) may be allowed; consult Royal Mail's website for further information.

Royal Mail *may* accept Category B substances that are termed as 'diagnostic specimens' for UK delivery only, providing they are packaged to P650 requirements and use Royal Mail's safe box packaging with a maximum of 50 ml or 50 g per package. Dry Ice cannot be used. Royal Mail will **not** transport any Category B substances abroad. Exempt substances can be sent both within the UK and abroad. See Royal Mail's website for further details on prohibited / restricted items and packaging.

Other postal operators in the UK generally follow Royal Mail's guidance.

ii Public transport

Category A infectious substances (those assigned to UN 2814 or UN 2900) must be carried **only** in vehicles displaying the necessary orange-coloured plates and carrying appropriate safety equipment, both as specified in the regulations, and the driver must be trained and certified (by the Department of Transport) to carry dangerous goods.

College personnel **must not** transport or carry such materials themselves either in their own, colleagues or QMUL owned vehicles or on any public transport including London Underground, Rail, taxis etc. Therefore, recognised specialist courier companies must be used for Category A transport.

Category B infectious substances (those assigned to UN 3373) must not be carried on public or private transport without permission from the operator / carrier. Transport for London (Underground, Buses) prohibit the carrying of dangerous goods on their transport network.

It must be noted that dry ice and liquid nitrogen are classified as 'hazardous substances' and therefore the operator / carrier needs to give permission for transport, even if the biological material is non-hazardous.

Exempt human and animal specimens or non-hazardous biological material which are packed and labelled in accordance with the requirements of the regulations *may* be carried by QMUL personnel by road or rail within the UK, subject to the following provisions.

- a) The package must be concealed from public view – either by placing in the boot or by concealing in an anonymous outer package such as a shopping bag.
- b) The package must never be left unattended at any stage.
- c) The QMUL employee must carry his / her ID card at all times.
- d) The package is not subjected to any rough handling or stowage.
- e) Should the package become lost, the person responsible should make every attempt to trace its whereabouts as soon as possible - this may involve contacting the relevant operator. Operators should be reassured that, providing the package is not opened there will be no risk to handlers. If the contact details are correctly displayed on the package, the finder will be in a position to contact the owner.

iii Couriers

The classification, packaging and labelling requirements as set out above are legislative requirements and must be met irrespective of the means of transport. Senders should give a full description of the goods to the courier company when arranging the shipment. This should include the UN number and proper shipping name. Some couriers may refuse to handle dangerous

goods (because they do not have the necessary authorisations etc) and others may impose additional special requirements.

iv Air

The air transport regulations specify that **dangerous goods must not be carried by passengers as/or in checked baggage, carry-on baggage or on their person - this applies to both Category A and Category B infectious substances.**

Dangerous goods must always be transported as separate packages **in the hold** and must always be declared. The operator/airline is required to report to the appropriate National Aviation Authority when undeclared or mis-declared dangerous goods are discovered, this is a serious offence and can result in prosecution by the authorities.

If individuals wish to take dangerous goods with them (as a separate package to go in the hold) they **must make advance arrangements** with the airline and complete an Air Waybill and a Shipper's Declaration for Dangerous Goods. Individual airlines have different requirements and may require early check in. The requirements for dry ice and other refrigerants must also be met.

Packages containing Exempt human or animal specimens *may* be carried in checked or carry-on baggage (but not on a person) provided they have been packed and labelled in accordance with the requirements of the transport regulations. The requirements for dry ice and other refrigerants must also be met.

Unless a specialist dangerous goods courier is used, senders of infectious substances are advised to **always** contact the operator / airline to check on their specific requirements for a particular shipment and to make any necessary arrangements for the consignment.

9 Operator variations / international customs

The carriage of any goods by road, rail, sea or air operator is a commercial matter for the carrier. An operator / carrier that does not wish to carry particular goods is under no legal obligation to do so and have the right to refuse to carry such goods (e.g. Transport for London state in their conditions of carriage that 'hazardous' or 'flammable' substances cannot be transported, (section 12.1.3)

http://www.tfl.gov.uk/assets/downloads/CoC_17_May_2009.pdf. It is the responsibility of the shipper to make advance arrangements with the operator / carrier to ensure smooth delivery.

Before sending any biological materials abroad, the person sending the goods (the consignor/shipper) should contact the person to whom they are being sent to (the consignee), to let them know shipping details and to check that the substance may be legally imported. The person **receiving** the materials is

generally regarded as the importer and the one responsible for obtaining, where necessary, all appropriate permits or licences. Importation of materials into the United States is particularly tightly regulated and there are restrictions even on some items that may be transported as non-dangerous goods. In contrast, fewer items require an import permit, licence or notification to be made when importing into the UK.

10 Receipt of infectious and non-infectious biological substances

A designated secure area is needed for receiving dangerous goods from deliveries with entry restricted to authorised staff. The floor and benches of the area should be impervious to solvents, acids, alkalis and disinfectants. A hand wash basin with non-hand operable taps and a fixed hatch / counter for delivery of substances is advised. Suitable trays or containers to hold leaking packages, equipment (both personal and disinfection) for dealing with damaged, leaking or mis-labelled packages should be in place. Emergency procedures for spills and procedures in the event of loss or theft of packages should be written and displayed. A secure cupboard, refrigerator or freezer may be required to hold dangerous goods until the end user receives it.

Reception and delivery staff must receive training in order to identify hazard labels and warnings, handle receipt of dangerous goods, and how to arrange onward transfer safely. Reception staff must not receive goods from a courier or postal person which are leaking / damaged or mis-labelled.

Reception and delivery staff must never touch or handle leaking or damaged packages. They must alert the laboratory manager or intended recipient immediately and await further instructions. If reception or delivery staff notice a spill from the package onto themselves or their clothing, they must remove the contaminated clothing, wash their hands or part of the body (if possible) and don fresh work clothing. Contaminated clothing must be autoclaved and further advice sought from occupational health / laboratory manager.

11 Summary Chart for Transport of Infectious Substances and biological material

UN ID	Proper Shipping Name	UN Class	Hazard Label	ADR Packing Instruction	Max net qty / pkg	IATA Packing Instruction	Max net qty / pkg (in hold of passenger aircraft or cargo aircraft)*	Max net qty / pkg (in cargo aircraft only)*	Notes
2814	INFECTIOUS SUBSTANCES AFFECTING HUMANS (liquid) or (solid)	6.2	Infectious Substance	620	No limit	602	50 ml or 50 g	4 litres or 4 kg	A81, A140
2900	INFECTIOUS SUBSTANCES AFFECTING ANIMALS (liquid) or (solid)	6.2	Infectious Substance	620	No limit	602	50 ml or 50 g	4 litres or 4 kg	A81, A140
3373	BIOLOGICAL SUBSTANCES CATEGORY B	6.2	UN3373 diamond	650	No limit	650	4 litres or 4 kg (1 litre per primary)	4 litres or 4 kg (1 litre per primary)	-
3245	GENETICALLY MODIFIED MICRO-ORGANISMS or ORGANISMS	9	Miscellaneous	-	No limit	-	No limit (100 ml or 100 g per primary)	No limit (100 ml or 100 g per primary)	A47
1845	Dry Ice	9	Miscellaneous	904	No limit	904	200 kg	200 kg	A48 A151

* Airline / Aircraft Operator variations may apply.

Special Provisions for air transport

A47 - Genetically modified micro-organisms and genetically modified organisms, which meet the definition of an infectious substance and the criteria for inclusion in Class 6.2, must be transported as UN 2814, UN 2900 or UN 3373 as appropriate.

A48 - Packaging tests are not considered necessary.

A81 - The quantity limits shown do not apply to body parts, organs or whole bodies. Transport in accordance with this Special Provision must be noted on the Shippers Declaration for Dangerous Goods.

A140 - For the purposes of *documentation*, the proper shipping name must be supplemented with the technical name. Technical names need not be shown on the package. When the infectious substances to be transported are unknown, but suspected of meeting the criteria for inclusion in Category A and assigned to UN 2814 or UN 2900, the words "suspected category A infectious substance" must be shown, in parentheses, following the proper shipping name on the Shipper's Declaration for Dangerous Goods, but not on the outer packaging.

A151 - When dry ice is used as a refrigerant for other than dangerous goods loaded in a unit load device or other type of pallet, the quantity limits per package do not apply. In such case the unit load device or other type of pallet must be identified to the operator and must allow the venting of the carbon dioxide gas to prevent dangerous build up of gas.

12 Emergency procedures

EMERGENCY RESPONSE PROCEDURES TRANSPORT OF INFECTIOUS SUBSTANCES

The following information is provided for use by carriers/operators in the event that a package containing **Infectious Substances** (of either **Class 6.2, Category A or B**) is involved in an incident resulting in spillage.

Mitigation procedures:

DO NOT CLEAN-UP OR DISPOSE OF INFECTIOUS SUBSTANCES, EXCEPT
UNDERSUPERVISION OF A SPECIALIST

- Isolate spill or leak area immediately in all directions.
- Keep unauthorized personnel away.
- Obtain identity of substance involved if possible and report the spill to the appropriate authorities.
- Do not touch or walk through spilled material.
- Do not touch damaged containers or spilled material unless wearing appropriate protective clothing.
- Be particularly careful to avoid contact with broken glass or sharp objects that may cause cuts or abrasions that could significantly increase the risk of exposure.
- Damaged packages containing solid CO₂ (dry ice) as a refrigerant may produce water or frost from condensation of air. Do not touch this liquid as it could be contaminated by the contents of the package.
- Liquid nitrogen may be present and can cause severe burns.
- Absorb spilled materials with earth, sand or other non-combustible material while avoiding direct contact.
- Cover damaged package or spilled material with damp towel or rag and keep wet with liquid bleach (5 % v/v) or other suitable disinfectant. Liquid bleach will generally effectively inactivate the released substance.

First Aid:

CAUTION: EXPOSED PERSON(S) MAY BE A SOURCE OF CONTAMINATION.

Persons administering first aid should take precautions to avoid personal exposure or secondary contamination of others.

- Move exposed person(s) to a safe isolated area.
- Call emergency medical services.
- If clothing and/or shoes are significantly contaminated, remove and isolate them. However, do not allow this to delay other first aid interventions.
- In case of contact of the substance to skin, eyes, nose or mouth, immediately flush the exposed area with copious amounts of running water. Continue this until emergency medical services arrive. Follow their advice for further decontamination.
- Most effects of exposure (inhalation, ingestion or skin contact) to substance are likely to be delayed.
- Ensure that medical personnel are aware of the substances involved, and take precautions to protect themselves.
- For further assistance, contact the appropriate public health authority.

Emergency contact details for the sender and recipient are provided with the documentation accompanying the package and shown on the package.

13 Infectious Substances - Classification flow chart

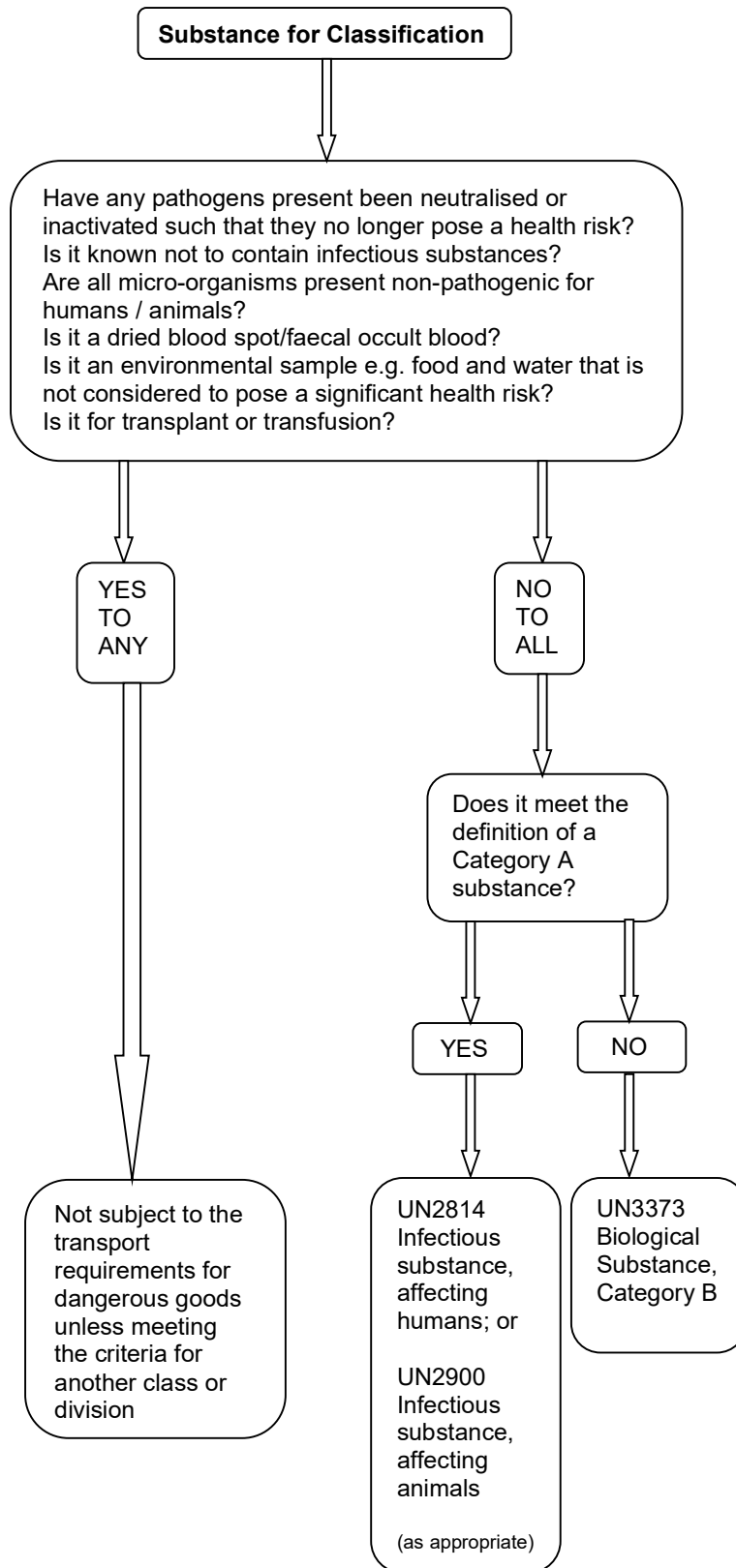

14 Category A and B - packaging and marking

Packing and Labeling of Category A Infectious Substances
(See Packing Instruction 602)

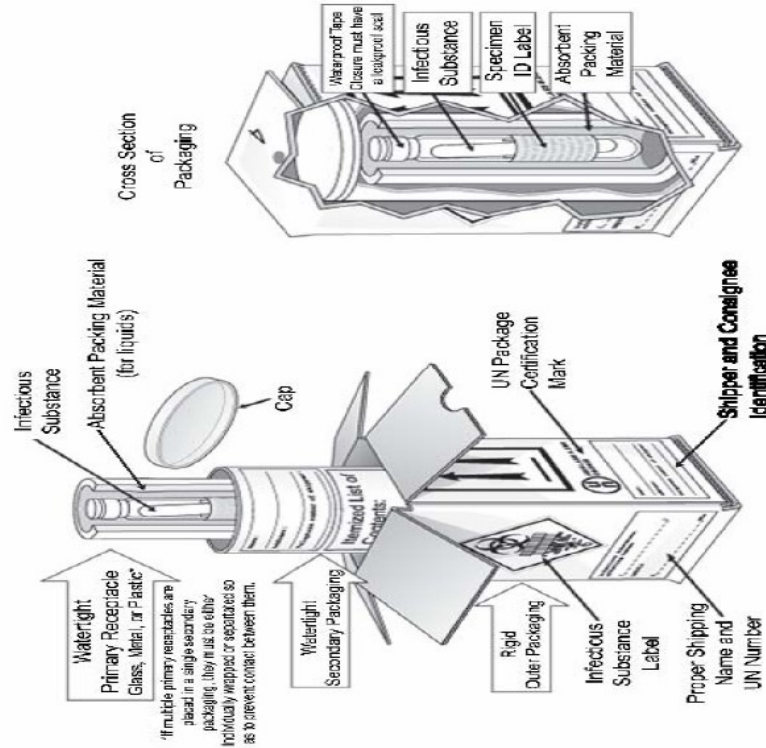

Packing and Labeling of Category B Infectious Substances
(See Packing Instruction 650)

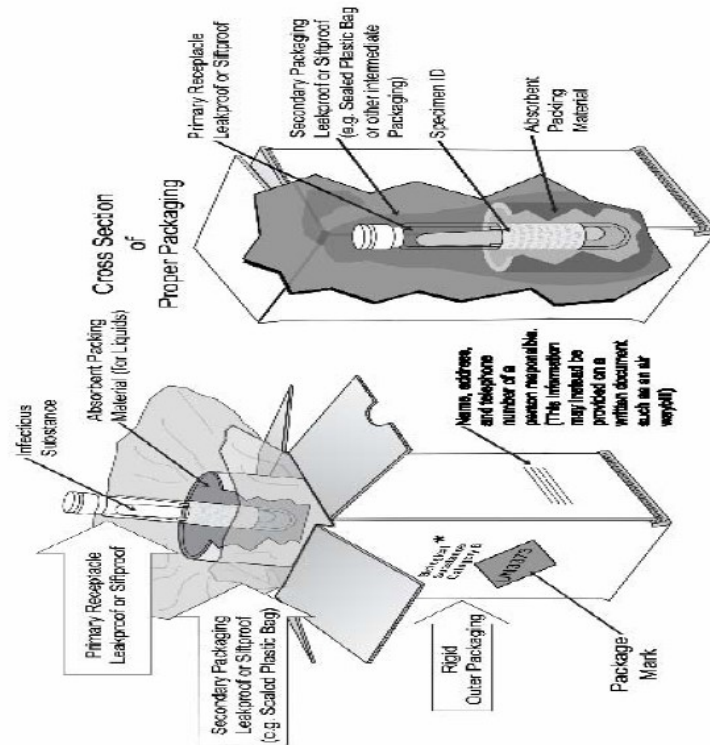

*The proper shipping names "Biological Substance, Category B", "Clinical Specimen" and "Diagnostic Specimen" are authorized until December 31, 2006. From January 1, 2007 only the proper shipping name "Biological Substance, Category B" will be authorized.

15 Table 1 - Category A (UN 2814 and 2900) Indicative List

These entries are for infectious substances carried **in any form**, unless otherwise indicated.

Note 1: The following list is not exhaustive. Infectious substances, including those containing new or emerging pathogens, which do not appear in the following list but which meet the same criteria, must be transported as a Category A infectious substance. In addition, if there is doubt as to whether or not a pathogen falls within this category it must be transported as a Category A infectious substance.

Note 2: In the following table, the micro-organisms indicated in bold are bacteria, mycoplasmas, rickettsiae or fungi. Non-culture forms of a pathogen that is a "cultures only" Category A substance should be assigned to Category B.

UN2814 INFECTIOUS SUBSTANCES AFFECTING HUMANS

Bacillus anthracis (cultures only)
Brucella abortus (cultures only)
Brucella melitensis (cultures only)
Brucella suis (cultures only)
Burkholderia mallei - Pseudomonas mallei – Glanders (cultures only)
Burkholderia pseudomallei – Pseudomonas pseudomallei (cultures only)
Chlamydia psittaci - avian strains (cultures only)
Clostridium botulinum (cultures only)
Coccidioides immitis (cultures only)
Coxiella burnetii (cultures only)
Crimean-Congo hemorrhagic fever virus
Dengue virus (cultures only)
Eastern equine encephalitis virus (cultures only)
Escherichia coli, verotoxigenic (cultures only)¹
Ebola virus
Flexal virus
Francisella tularensis (cultures only)
Guanarito virus
Hantaan virus
Hantaviruses causing hantavirus pulmonary syndrome (Hantaviruses causing hemorrhagic fever with renal syndrome)
Hendra virus
Hepatitis B virus (cultures only)
Herpes B virus (cultures only)
H5 or H7 avian influenza virus (cultures only)
Human immunodeficiency virus (cultures only)
Japanese Encephalitis virus (cultures only)
Junin virus
Kyasanur Forest disease virus
Lassa virus
Machupo virus
Marburg virus
Monkeypox virus
Mycobacterium tuberculosis (cultures only)¹
Nipah virus
Omsk hemorrhagic fever virus

Poliovirus (cultures only)
Rabies virus²
Rickettsia prowazekii (cultures only)
Rickettsia rickettsii (cultures only)
Rift Valley fever virus (cultures only)
Russian spring-summer encephalitis virus (cultures only)
Sabia virus
Shigella dysenteriae type 1 (cultures only)¹
Tick-borne encephalitis virus (cultures only)
Variola virus
Venezuelan equine encephalitis virus (cultures only)
West Nile virus (cultures only)
Yellow fever virus (cultures only)
Yersinia pestis (cultures only)

¹ For **land modes only**, when cultures are intended for diagnostic or clinical purposes, they may be classified as Category B.

² For **land modes only**, cultures only.

UN2900 INFECTIOUS SUBSTANCE AFFECTING ANIMALS only

African horse sickness virus (only for air)
African swine fever virus (cultures only)
Avian paramyxovirus Type 1
Velogenic Newcastle disease virus (cultures only)
Classical swine fever virus (cultures only)
Foot and mouth disease virus (cultures only)
Goatpox virus (cultures only)
Lumpy skin disease virus (cultures only)
Mycoplasma mycoides - contagious bovine pleuropneumonia (cultures only)
Peste des petits ruminants virus (cultures only)
Rinderpest virus (cultures only)
Sheep-pox virus (cultures only)
Swine vesicular disease virus (cultures only)
Vesicular stomatitis virus (cultures only)

References for Transport of Infectious and other biological substances:

CDG HSE website:

<http://www.hse.gov.uk/cdg/index.htm>

Royal Mail Prohibited and Restricted items:

<http://www.royalmail.com/portal/rm/jump2?catId=400023&mediaId=400044>

Department of Transport:

<http://www.dft.gov.uk/pgr/freight/dgt1/guidance/guidancenonclass7/guidanceontransportofinfect3186>

<http://www.dft.gov.uk/pgr/freight/dgt1/guidance/guidancenonclass7/dftdgguidancenote12>

ADR regulations:

<http://www.unece.org/trans/danger/publi/adr/adr2007/07ContentsE.html>

WHO Guidance for Transport of Infectious Substances:

http://www.who.int/csr/resources/publications/biosafety/WHO_CDS_EPR_2007_2cc.pdf

Department of Health Guidance:

http://www.dh.gov.uk/en/Publicationsandstatistics/Publications/PublicationsPolicyAndGuidance/DH_075439

IATA Guidance and Packing Instructions:

http://www.iata.org/whatwedo/cargo/dangerous_goods/infectious_substances.htm

Procedure / Guidance Note B16

Bio security

The provisions set out in Part 7 and Schedule 5 of the Anti-Terrorism, Crime and Security Act (ATCSA) 2001 place an obligation on Heads / Managers of laboratories holding and / or using stocks of **specified disease organisms** and **toxins** (listed on the following pages) to notify their holdings to the Home Office, and to comply with any reasonable security requirements which the police may impose after an inspection of the premises.

The recent amendments to Part 7 and Schedule 5 of ATCSA (2001) includes guidance notes that seek to clarify some questions concerned with use of these agents in clinical, diagnostic and medicinal applications.

For instance, storage of clinical samples containing listed pathogens or toxins for reference purposes do fall under the provisions of the Act and have to be notified to the Home Office.

Various other points are addressed in the guidance including whether nucleic acid sequences from listed pathogens need to be notified.

Annexes A and B of the Guidance document list the pathogens and toxins to be notified (also listed in the appendix to this document) and provide a flow diagram to help in deciding if work with organisms and toxins falls within the scope of the Act.

If Schedule 5 agents are to be used or stored in an Institute / School or Department, the QMUL Biological Safety Adviser **must** be notified prior to the materials being received.

The guidance documents are held by the Health & Safety Directorate to help in evaluating the security and personnel requirements for the holding and use of Schedule 5 substances.

The QMUL Biological Safety Adviser holds a central register of all Schedule 5 substances held by the University.

The list of pathogens and toxins falling under this legislation is available at <https://www.legislation.gov.uk/ukpga/2001/24/schedule/5>

The National Counter Terrorism Security Office (NaTSCO) are the lead government agency tasked with this legislation and their primary role is to provide help, advice and guidance on all aspects of counter terrorism protective security to specified industry sectors. <https://www.gov.uk/government/organisations/national-counter-terrorism-security-office>

Working with agents causing Transmissible Spongiform Encephalopathy (TSE)

Categorisation

The causative agents of the following diseases are all classified as Hazard Group (HG) 3 agents as listed in the Health and Safety Executive's Approved List of Biological Agents.

- Creutzfeldt-Jakob disease (CJD) including variant CJD (vCJD);
- Gerstmann-Sträussler-Scheinker Syndrome (GSS);
- Kuru;
- Fatal Familial Insomnia (FFI);
- Bovine Spongiform Encephalopathy (BSE) and similar diseases, including feline spongiform encephalopathy (FSE), spongiform encephalopathy (SE) in captive exotic ungulates, transmissible mink encephalopathy (TME) and chronic wasting disease (CWD).
- BSE experimentally transmitted to other species is also included.

Required Containment Level for TSE agents

Based on the current Hazard Grouping of TSE agents, Containment Level 3 is recommended for all work with TSE agents.

In some circumstances the risk of a HG3 agent being present in a sample is extremely low. For example, the appropriate containment measure for work with tissues derived for surveillance purposes will depend on what is known about the incidence of infection in the population that is being studied, and as a result the risk assessment may show that Containment Level (CL) 2 is appropriate for work with the tissues. See <https://www.gov.uk/government/publications/guidance-from-the-acdp-tse-risk-management-subgroup-formerly-tse-working-group> for further information on high, medium and low TSE risk tissues.

Any decision to change the containment conditions should only be taken after performing a local risk assessment (see COSHH ACoP and Guidance, in particular Schedule 3 and Appendix 2) that takes into account: the nature of the work; the quantity and type of material being handled; and the procedures and equipment that will be used – consider the potential for dispersal of the agent, for contamination of workers, equipment or surfaces at all stages of the activity including handling, processing and disposal, and for contamination during the setting up, servicing and maintenance of the equipment.

Scrapie

The causative agent of scrapie (and other TSE agents known not to be linked to BSE) is not listed in the Approved List of Biological Agents because there is no evidence of transmission of disease to humans to date. However, as a

precaution, work with well characterised laboratory strains of scrapie should be carried out at CL2.

Recent concern about BSE transmission from sheep has led to a debate on whether all scrapie strains should be handled at CL3. As this debate is ongoing, a precautionary approach should be adopted where extra precautions, above those normally required at CL2, may be necessary for handling unidentified field isolates.

Decontamination

Many of the standard methods of decontamination cannot ensure complete inactivation of TSE agents, the emphasis must be on the removal of the agent by thorough cleaning, followed by an appropriate autoclaving or liquid chemical treatment.

Chemical disinfectants

- 1 20,000 ppm available chlorine of sodium hypochlorite for 1 hour (Dichloroisocyanurate does not deactivate TSE agents)
- 2 1M sodium hydroxide for 1 hour
- 3 For formalin-fixed histological samples only, 96% formic acid for 1 hour

Other chemical disinfectants are ineffective.

Gaseous disinfectants

None are effective

Physical processes

None are effective for sterilisation.

Note: even use of a porous load steam sterilizer 134-137°C for a single cycle of 18 minutes is ineffective. Six successive cycles of 3 minutes each was previously recommended but is now known not to be completely effective.

Strains of TSE agent vary in their sensitivity to heat. However, autoclaving still remains an important method of **reducing** infectivity. Combinations of some processes could be effective (e.g. chemical/physical), for example, autoclaving with sodium hydroxide.

Laboratory equipment

Owing to the difficulties associated with their decontamination, it is recommended that safety cabinets used for work with TSE agents should be of the type with the facility for removing HEPA filter units by bagging.

Whether or not bagging of the filter as it is withdrawn is possible, spraying the filter face after fumigation and before removal, with e.g. hair spray lacquer, will help to limit the shedding of particulate matter.

Dental equipment

There appears to be no evidence that human dental tissue including dental pulp contains abnormal prion protein; therefore the likelihood of TSE agent transmission by dental instruments particularly endodontic files and reamers is low. Similarly the likelihood of tonsillar abrasion i.e. contact with a known high-risk tissue during dentistry is normally considered to be remote. Dental instruments are frequently difficult to clean effectively and guidance given by the British Dental Association should be followed.

Laboratory waste containing TSE material

The following laboratory waste should be incinerated:

- waste from definite/probable/at risk patients that could contain high or medium risk tissue;
- waste from the post-mortem examination of definite/probable/at risk patients; and
- carcasses and other associated material from all animals experimentally infected with a TSE agent.

Other human clinical waste and animal waste from laboratories, which will contain low risk material or items contaminated by such material, can be disposed of by routine methods for disposing of clinical and animal waste.

Further references: <https://www.gov.uk/government/publications/guidance-from-the-acdp-tse-risk-management-subgroup-formerly-tse-working-group>